

VOLVO

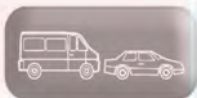

240/260 SERIES

10/74 - 12/93

STEERING



SS309



SS309

FRONT SUSPENSION



SS126

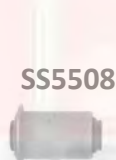

SS5508



SS5509



SS5509

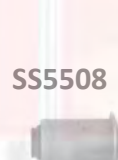

SS5508



SS125

Description	Application	Part No	Product	OE Ref.No.
Tie rod end		SS309		1205658
Ball joint	manual steering	SS110		
Ball joint left	power steering	SS126		1273139
Ball joint right	power steering	SS125		1273140
Link rod		SS5509		
Bush wishbone rearward		SS5508		

340/360 SERIES

09/75 - 08/91

STEERING



SS945



SS355



SS355



SS945

FRONT SUSPENSION



SS115

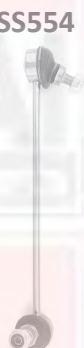

SS554



SS554



SS115

Description	Application	Part No	Product	OE Ref.No.
Tie rod end	76-9/85 only	SS945		32111116463
Tie rod end	9/85-10/91 only	SS355		3211955
Link rod left		SS554		3209407
Link rod right		SS553		3266894
Ball joint		SS115		3268631

VOLVO

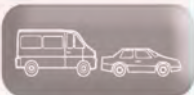

440

09/88 - 08/97

STEERING



SS366

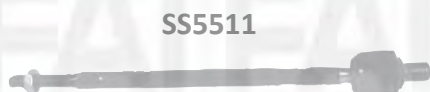

SS5511



SS5511



SS366

FRONT SUSPENSION



SS2096



SS2097

SS556

SS555



SS2098



SS177



SS4331



SS4331



SS177

REAR SUSPENSION

SS4428



SS4428



Description	Application	Part No	Product	OE Ref.No.
Tie rod end		SS366		34483347
Rack end	power steering	SS5511		3410412
Wishbone left	exc. auto/diesel	SS2096		3443998
Wishbone left	auto & diesel only	SS2097		3421396
Wishbone right	man. only	SS2098		3443999
Ball joint		SS177		410519
Bush wishbone		SS4331		
Link rod left		SS556		3467713
Link rod right		SS555		3467714
Link rod rear		SS4428		3434868

VOLVO

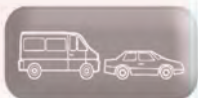

460

09/88 - 08/97

STEERING



FRONT SUSPENSION



REAR SUSPENSION



Description	Application	Part No	Product	OE Ref.No.
Tie rod end		SS366		34483347
Rack end	power steering	SS5511		3410412
Wishbone left	exc. auto/diesel	SS2096		3443998
Wishbone left	auto & diesel only	SS2097		3421396
Wishbone right	man. only	SS2098		3443999
Ball joint		SS177		410519
Bush wishbone		SS4331		
Link rod left		SS556		3467713
Link rod right		SS555		3467714
Link rod rear		SS4428		3434868

VOLVO

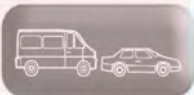

480

09/85 - 12/95

STEERING



SS366

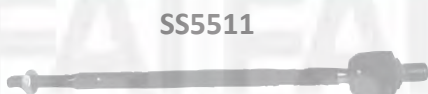

SS5511



SS5511



SS366



SS2096



SS2097

FRONT SUSPENSION

SS556

SS555



SS2098



SS177



SS4331



SS4331



SS177

REAR SUSPENSION

SS4428



SS4428



Description	Application	Part No	Product	OE Ref.No.
Tie rod end		SS366		34483347
Rack end	power steering	SS5511		3410412
Wishbone left	exc. auto/diesel	SS2096		3443998
Wishbone left	auto & diesel only	SS2097		3421396
Wishbone right	man. only	SS2098		3443999
Ball joint		SS177		410519
Bush wishbone		SS4331		
Link rod left		SS556		3467713
Link rod right		SS555		3467714
Link rod rear		SS4428		3434868

VOLVO

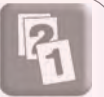

740 / 760

04/82 - 08/92

STEERING



SS309

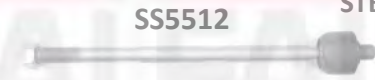

SS5512

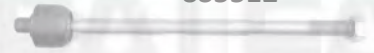

SS5512



SS309

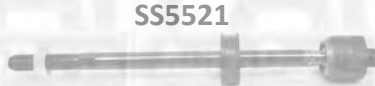

SS5521



SS5521

FRONT SUSPENSION



SS907



SS5517



SS560



SS560

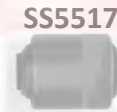

SS5517



SS907

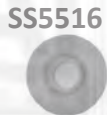

SS5516

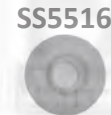

SS5516

Description	Application	Part No	Product	OE Ref.No.
Tie rod end		SS309		1205658
Rack end	CAM PAS 08/88 -	SS5512		1387463
Rack end	ZF PAS	SS5521		1387356
Ball joint		SS907		2704773
Bush wishbone outer		SS5516		13595992
Bush wishbone inner		SS5517		13296553
Link rod		SS560		132935

VOLVO

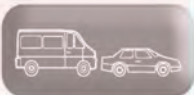

850

92 - 96

STEERING



SS3054

SS1230

FRONT SUSPENSION

SS1231

SS3054

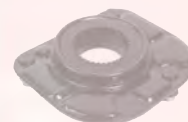

SS1228

SS4257

SS4257

SS1229



SS904

SS4256

SS4256

SS904



REAR SUSPENSION

SS3055

SS3055



Description	Application	Part No	Product	OE Ref.No.
Tie rod end left		SS905		2715985
Tie rod end right		SS906		2715993
Rack end		SS2552		3546266
Kit mounting		SS3054		35461896
Wishbone left		SS1228		2719011
Wishbone right	Turbo/Turbodiesel	SS1229		2719029
Wishbone left	Turbo/Turbodiesel	SS1230		2722734
Wishbone right	Turbo/Turbodiesel	SS1231		2722742
Ball joint	92-93 models with alloy wheels	SS904		2715910
Bush wishbone forward	Turbo/TurboD only	SS4257		
Bush wishbone	exc Turbo/TurboD	SS4256		6550145P
Link rod		SS558		13878608
Strut mount rear		SS3055		35116151

VOLVO

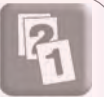

940

09/90 - 97

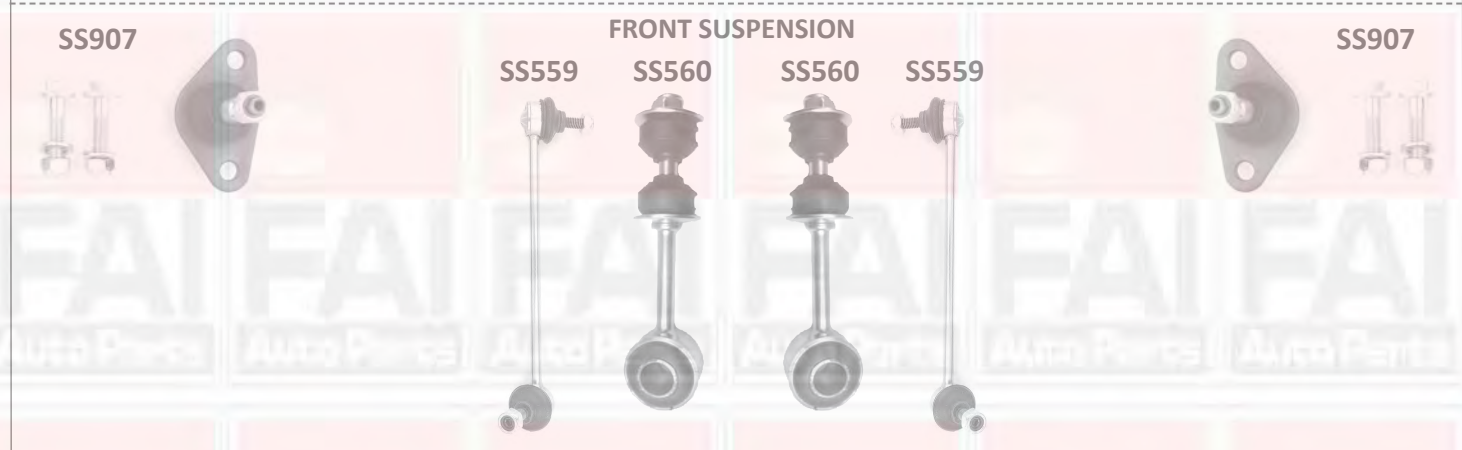
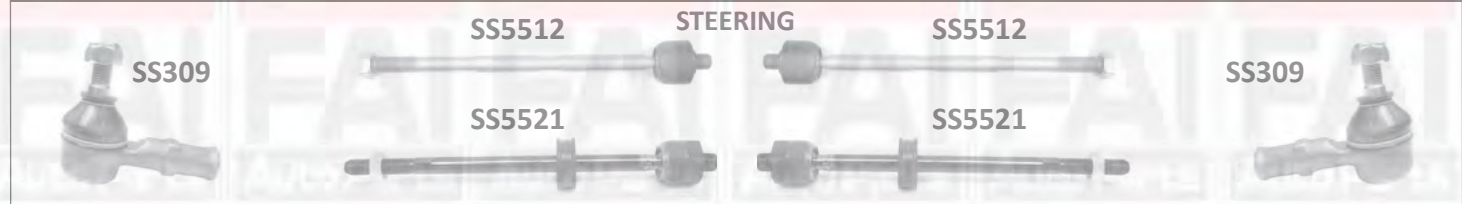

Description	Application	Part No	Product	OE Ref.No.
Tie rod end	CAM/ZF PAS	SS309		1205658
Rack end	CAM	SS5512	length 305mm	1387463
Rack end	ZF rack	SS5521	Length 310mm	1387356
Link rod	94-97 only	SS559		6819253
Link rod	9/90-94 only	SS560		132935
Ball joint		SS907		2704773
Link rod rear		SS933		

VOLVO

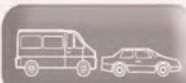

960

91 - 96



SS309

SS5512

STEERING

SS5512

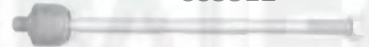
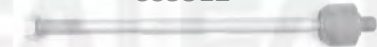

SS309



SS5521

SS5521



SS907



FRONT SUSPENSION

SS559

SS560

SS560

SS559



SS907

SS933



REAR SUSPENSION

SS933



Description	Application	Part No	Product	OE Ref.No.
Tie rod end	CAM/ZF PAS	SS309		1205658
Rack end	CAM	SS5512	Length 305mm	1387463
Rack end	ZF	SS5521	Length 310mm	1387356
Link rod	94-97 only	SS559		6819253
Ball joint		SS907		2704773
Link rod	9/90-94 only	SS560		132935
Link rod rear		SS933		

VOLVO



C70

03/98 - 10/05

STEERING



FRONT SUSPENSION

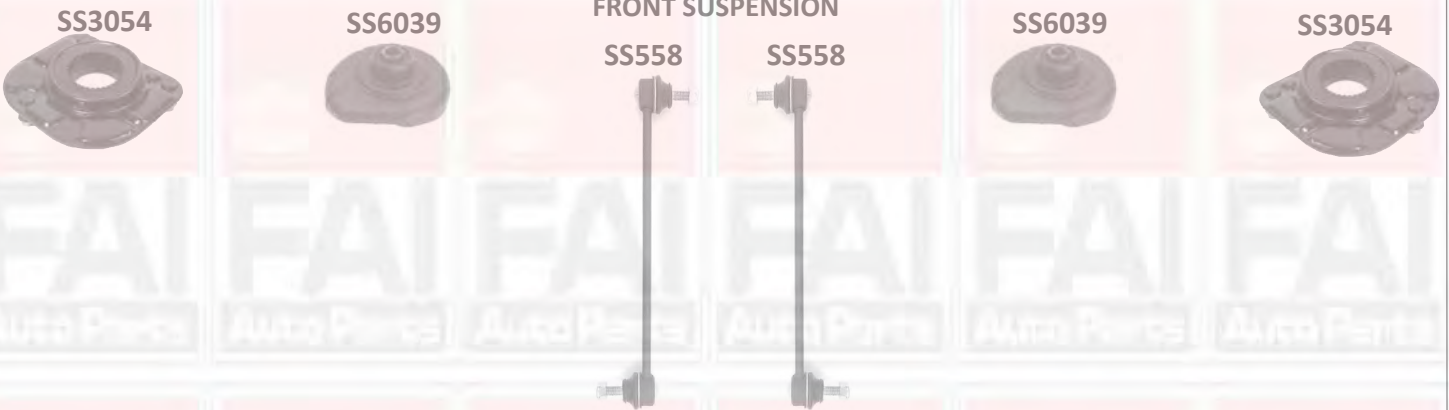

REAR SUSPENSION



Description	Application	Part No	Product	OE Ref.No.
Tie rod end left		SS905		2715985
Tie rod end right		SS906		2715993
Rack end		SS2552		3546266
Kit mounting		SS3054		35461896
Strut mount		SS6039		
Link rod		SS558		13878608
Strut mount rear		SS3055		35116151

VOLVO

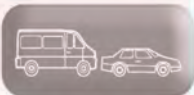

C70

09/05 -

STEERING

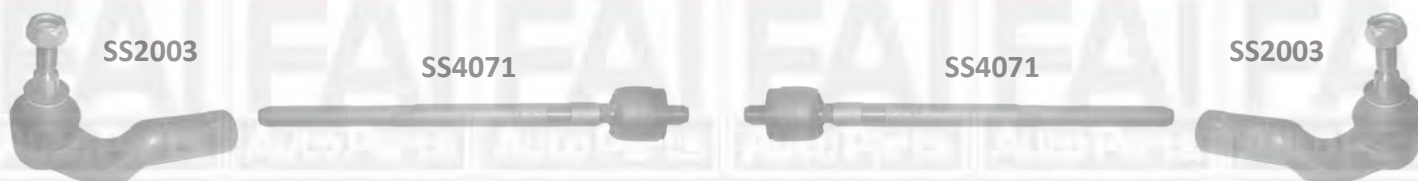

SS2042

FRONT SUSPENSION

SS2043

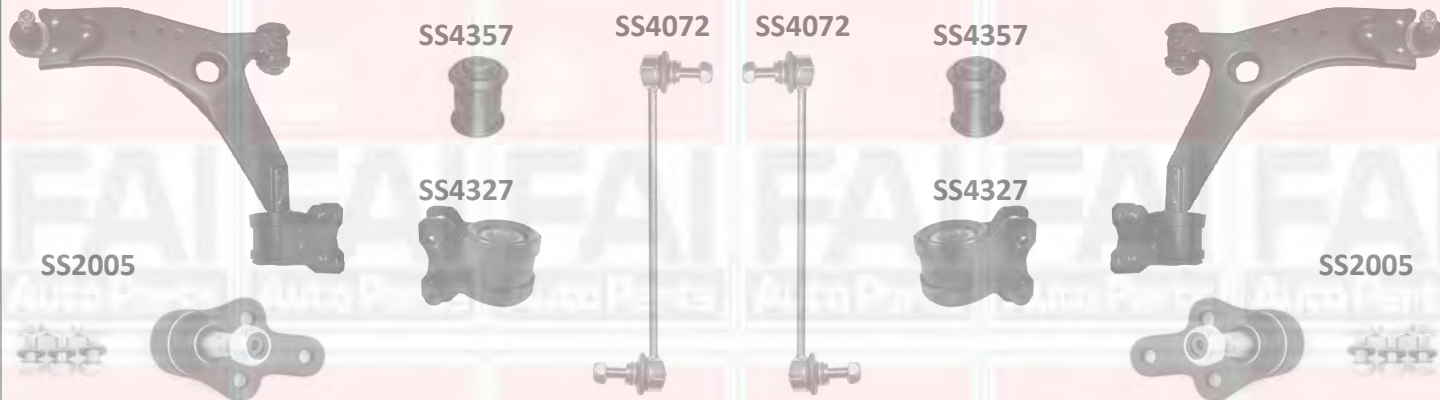

REAR SUSPENSION

SS683

SS683



Description	Application	Part No	Product	OE Ref.No.
Tie rod end left		SS2003		1251937
Tie rod end right		SS2004		1317446
Rack end		SS4071		3M513L519AA
Wishbone left		SS2042		1234375
Wishbone right		SS2043		1234371
Ball joint		SS2005		1234382
Bush wishbone forward		SS4357		
Bush wishbone rearward		SS4327		
Link rod		SS4072		12309069
Arm rear upper		SS683		1061659

VOLVO



VOLVO

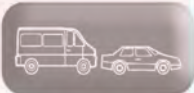

S40 I / V40

11/95 - 06/04

STEERING

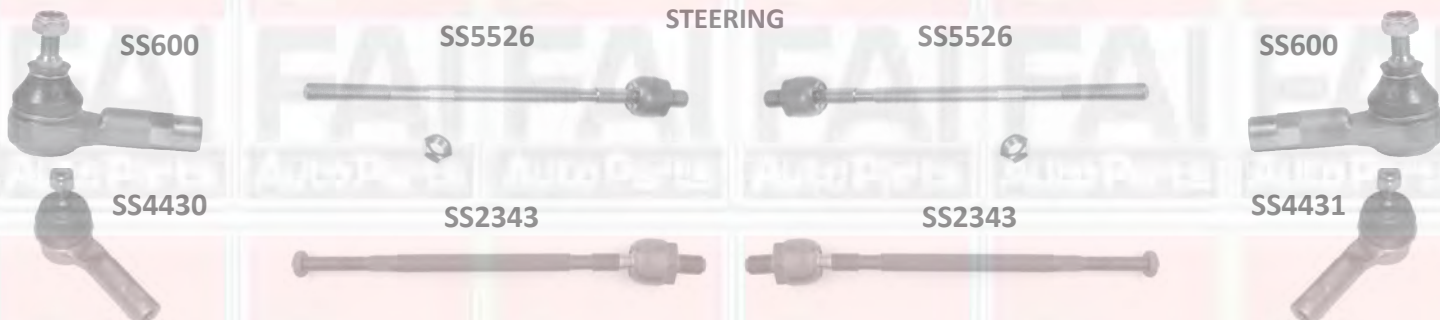

FRONT SUSPENSION

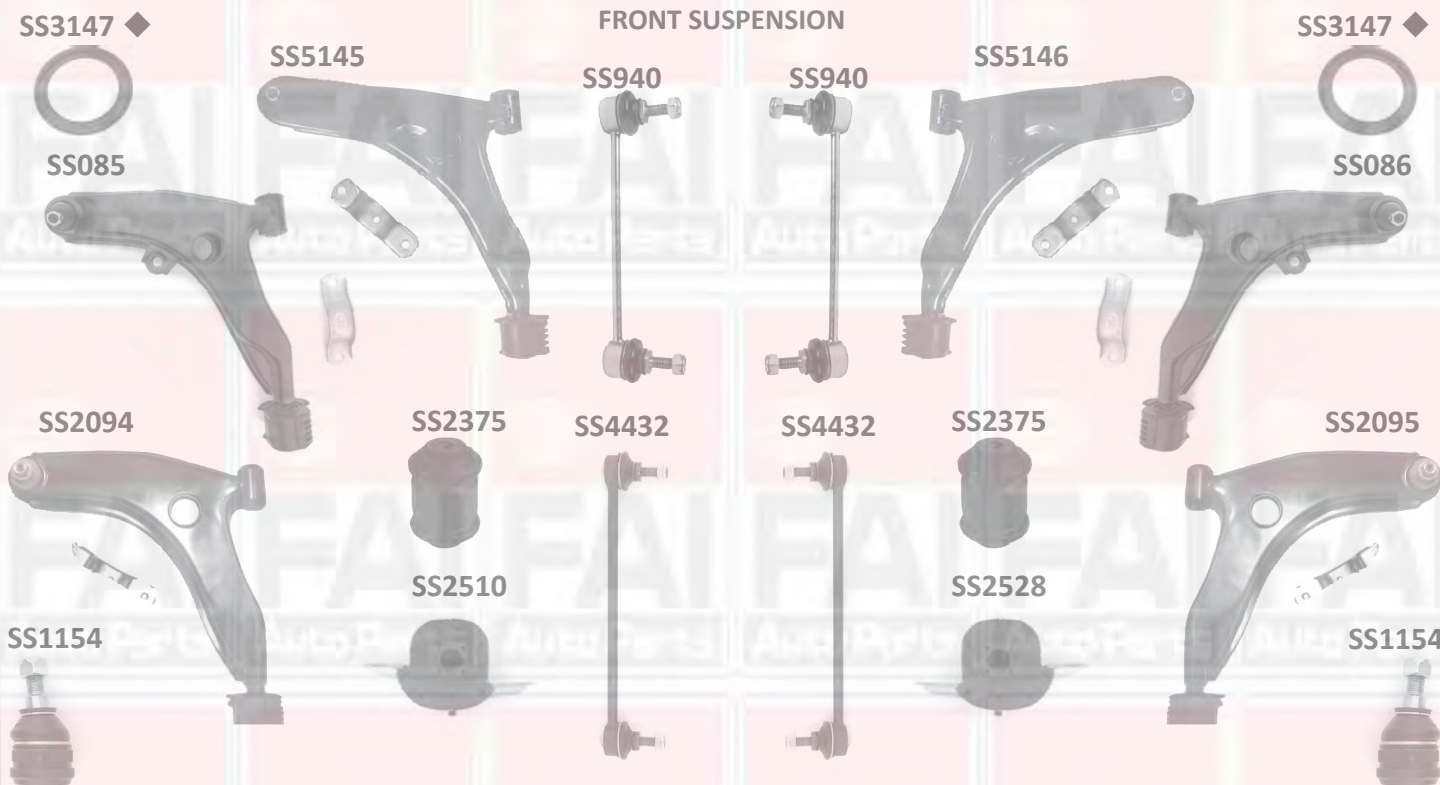

REAR SUSPENSION



VOLVO



S40 I / V40 (continued)

11/95 - 06/04

Description	Application	Part No	Product	OE Ref.No.
Tie rod end		SS600	12mm pin	5682028000
Tie rod end left	01-05 only	SS4430		274225
Tie rod end right	01-05 only	SS4431		274226
Rack end	01-05 only	SS5526		274224
Rack end		SS2343		MR244901
Strut mount bearing	600000 ->	SS3147 ◆		
Wishbone right	1996-98 only	SS085		MR179480
Wishbone right	1996-98 only	SS086		MR179480
Wishbone left	98-01	SS2094		30887025
Wishbone right	98-01	SS2095		30887033
Wishbone left	2001-2004	SS5145		3086388
Wishbone right	2001-2004	SS5146		3086388
Ball joint		SS1154		5450314200
Bush wishbone forward		SS2375		
Bush wishbone rearward right		SS2528		
Bush wishbone rearward left		SS2510		
Link rod	96-00 only	SS940		MR131680
Link rod	01-05 only	SS4432		30884179
Arm rear lower		SS2099		30620785
Arm rear upper	00 - 12/03	SS2102	L = 259mm	30620786
Arm rear right		SS2129	L - 143mm	30818091
Arm rear right		SS2130	L - 143mm	30818091
Arm rear left		SS2131	L - 226mm	MB809221
Arm rear right		SS2132	L - 226mm	MB809220
Arm rear upper	00 - 04	SS6040		
Link rod rear		SS5567		
Bush trailing arm rear		SS5527		30851257
Sprung seat		SS3148 ◆		

VOLVO

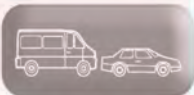

S40 II / V50

06 / 03 -

STEERING

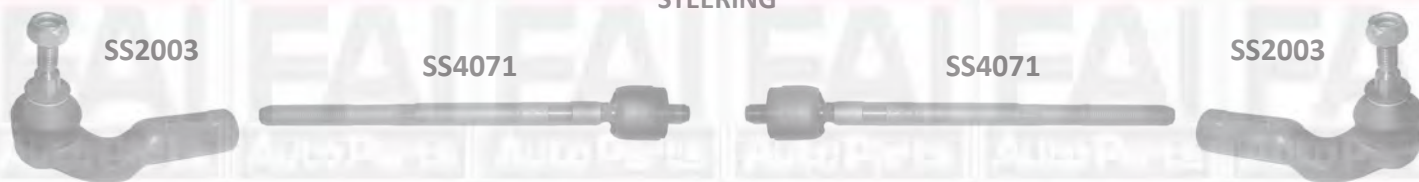

SS2042

FRONT SUSPENSION

SS2043



REAR SUSPENSION

SS685

SS685

Description	Application	Part No	Product	OE Ref.No.
Tie rod end left		SS2003		1251937
Tie rod end right		SS2004		1317446
Rack end		SS4071		3M513L519AA
Wishbone left		SS2042	18mm ball pin	1234375
Wishbone right		SS2043	18mm ball pin	1234371
Wishbone left		SS2600 ◆	21mm ball pin	1420858
Wishbone right		SS2601 ◆	21mm ball pin	1420859
Ball joint		SS2005	18mm ball pin	1234382
Ball joint		SS2602 ◆	21mm ball pin	1470387
Bush wishbone rearward		SS4327		
Bush wishbone forward		SS4357		
Link rod		SS4072		12309069
Link rod rear		SS685		1061702

VOLVO

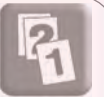

S60

07/00 -

STEERING



SS3149 ◆

FRONT SUSPENSION

SS3149 ◆



SS1327

SS1327



SS6041

SS4338

SS4338

SS6042



SS4339

SS4339

SS1326

SS1326



REAR SUSPENSION

SS3150 ◆

SS4433

SS4433

SS3150 ◆

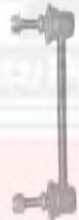

Description	Application	Part No	Product	OE Ref.No.
Tie rod end left		SS2355	M14 x 1.5mm	274175
Tie rod end		SS2550	M14 x 1.5mm	274176
Rack end		SS2551		274179
Strut mount with bearing		SS3149 ◆		
Wishbone left		SS6041		8649543
Wishbone right		SS6042		8649544
Bush wishbone forward		SS4338		
Bush wishbone rearward		SS4339		
Ball joint		SS1326		274548
Link rod		SS1327		274203
Link rod rear		SS4433		8672446
Strut mount		SS3150 ◆		

VOLVO

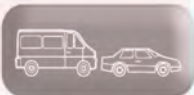

S70 / V70

11/96 - 10/01

SS2552

STEERING

SS2552



SS905



SS2551



SS2551



SS906



SS3054

SS6039

FRONT SUSPENSION

SS6039

SS3054



SS1228

SS4257

SS558

SS558

SS4257

SS1229



SS4256

SS4256

SS1230

SS1231



REAR SUSPENSION

SS3055

SS3151 ◆

SS3151 ◆

SS3055

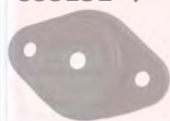

Description	Application	Part No	Product	OE Ref.No.
Tie rod end left		SS905		2715985
Tie rod end right		SS906		2715993
Rack end		SS2552		3546266
Rack end	00-01 - SMI	SS2551		274179
Kit mounting		SS3054		35461896
Strut mount		SS6039		
Wishbone left	exc Turbo	SS1228		2719011
Wishbone right	exc Turbo	SS1229		2719029
Wishbone left	Turbo only	SS1230		2722734
Wishbone right	Turbo only	SS1231		2722742
Bush wishbone forward	Turbo/TurboD	SS4257		
Bush wishbone	exc Turbo/TurboD	SS4256		6550145P
Link rod		SS558		13878608
Strut mount rear		SS3151 ◆		
Strut mount rear		SS3055		35116151

VOLVO

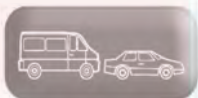

V70 MkII

99 - 07

STEERING



FRONT SUSPENSION

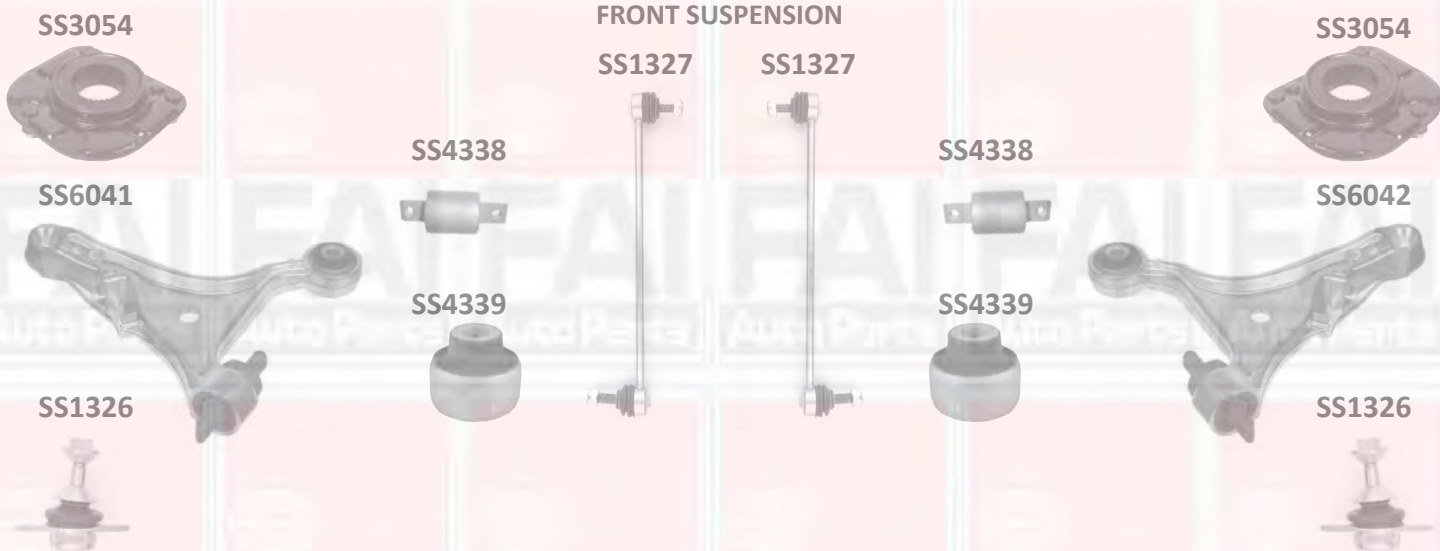

REAR SUSPENSION



Description	Application	Part No	Product	OE Ref.No.
Tie rod end left		SS2355	M14 x 1.5mm	274175
Tie rod end		SS2550	M14 x 1.5mm	274176
Rack end		SS2551		274179
Kit mounting	11/99-01 only	SS3054		35461896
Wishbone left		SS6041		8649543
Wishbone right		SS6042		8649544
Bush wishbone forward		SS4338		
Bush wishbone rearward		SS4339		
Ball joint		SS1326		274548
Link rod		SS1327		274203
Strut mount rear	11/99-01 only	SS3055		35116151
Link rod rear		SS4433		8672446

VOLVO

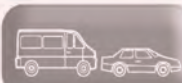

S80

98 - 06

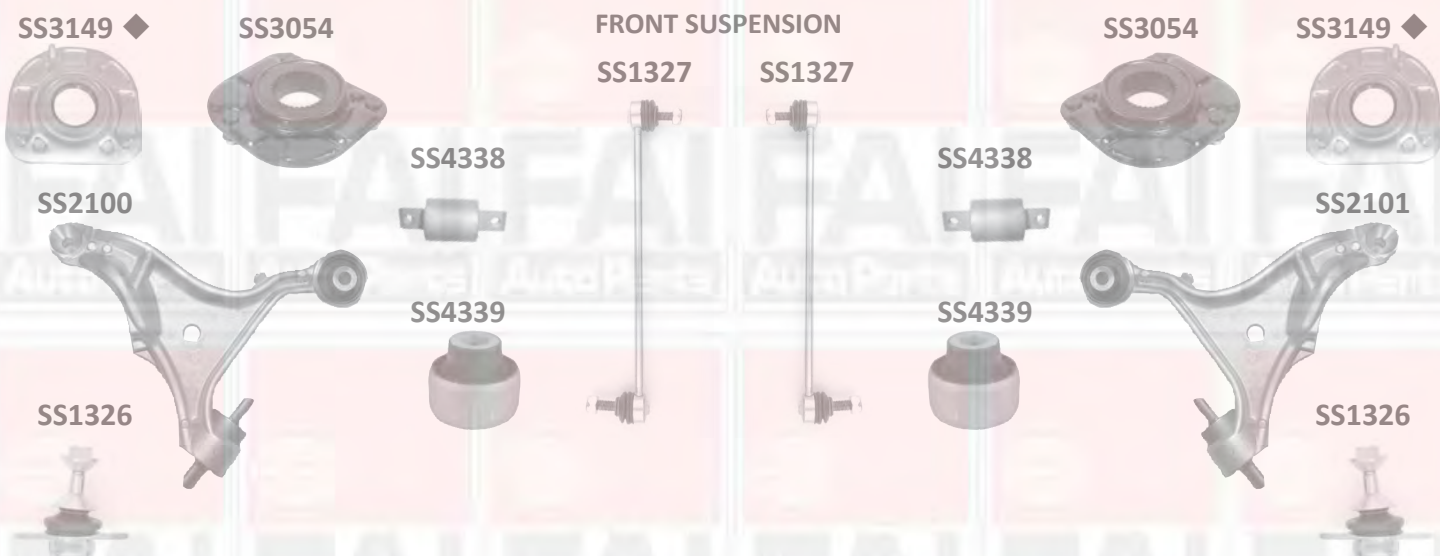
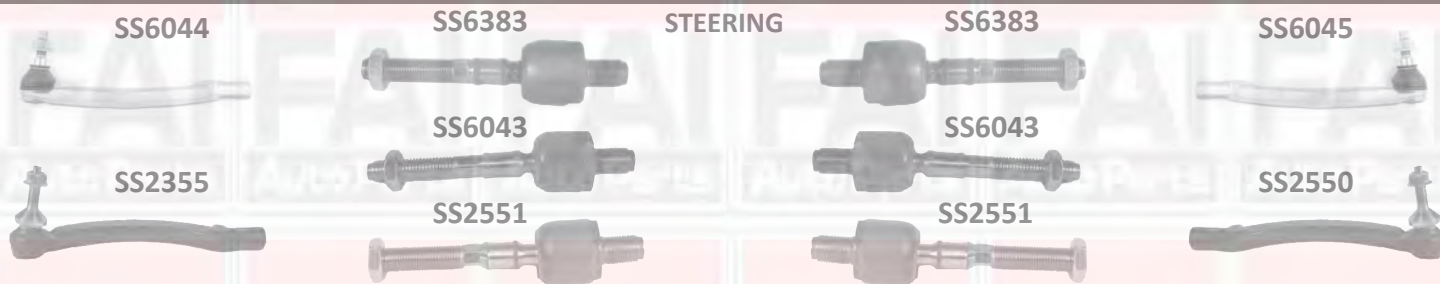

Description	Application	Part No	Product	OE Ref.No.
Tie rod end outer left	5/98-1/00 only	SS6044	M14 x 2.0mm	272416
Tie rod end outer right	5/98-1/00 only	SS6045	M14 x 2.0mm	272417
Tie rod end left	1/00-3/06	SS2355	M14 x 1.5mm	274175
Tie rod end	1/00-3/06	SS2550	M14 x 1.5mm	274176
Rack end	->12/03 - SMI	SS6383		274279
Rack end	5/98-1/00 only	SS6043	thread length 16.5mm	274428
Rack end	1/04-03/06 - ZF	SS2551	For steering manufacturer - ZF	274179
Strut mount		SS3149 ◆		
Kit mounting	-> 153439	SS3054		35461896
Wishbone left	5/98-00 only	SS2100		8649541
Wishbone right	5/98-00 only	SS2101		8649542
Ball joint		SS1326		274548
Link rod		SS1327		274203
Strut mount rear	-> 153439	SS3055		35116151
Strut mount		SS3150 ◆		

VOLVO

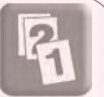

S80 II

08/06 -

STEERING

SS6224



SS6223



FRONT SUSPENSION

SS6221

SS6221



SS6226



SS6226



REAR SUSPENSION

SS6445

SS6445



Description	Application	Part No	Product	OE Ref.No.
Tie rod end left		SS6224		1433272
Tie rod end right		SS6223		1433273
Ball joint		SS6226		
Link rod		SS6221		1377849
Link rod rear		SS6445		

VOLVO

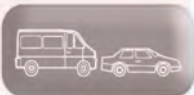

S90 / V90

11/96 - 04/99

STEERING

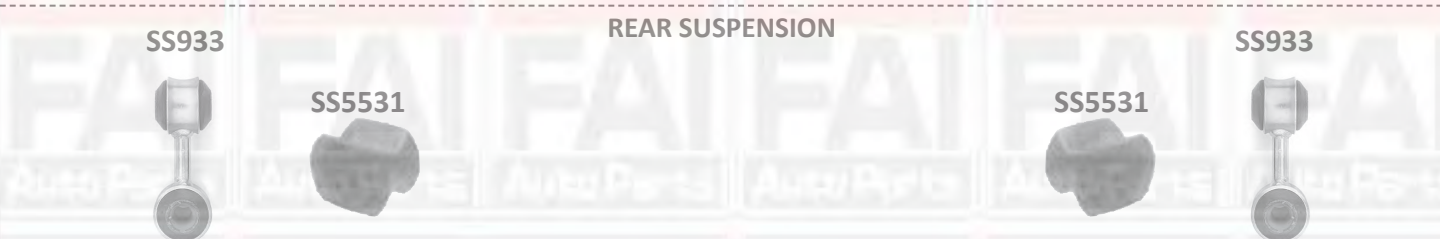
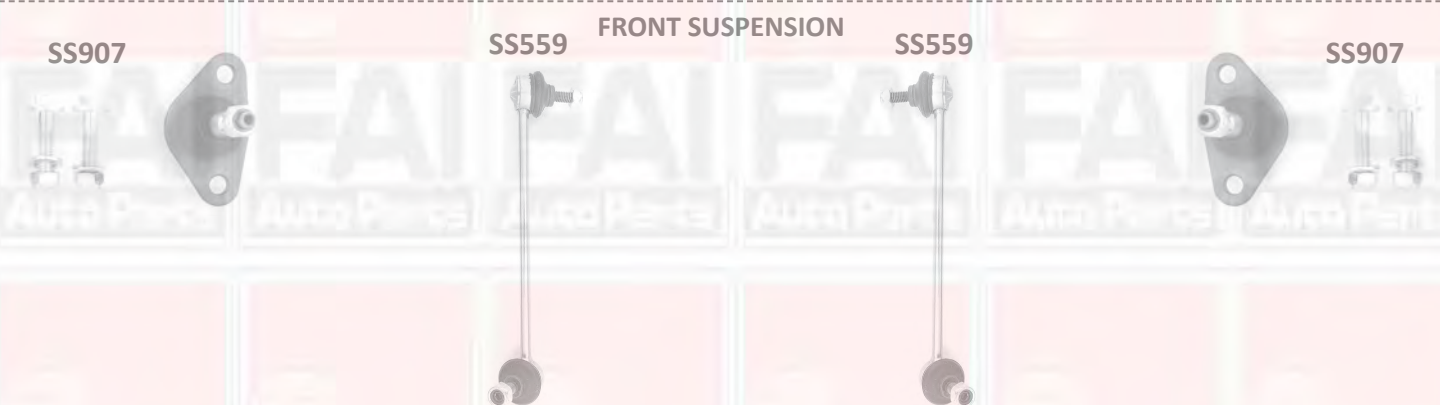

Description	Application	Part No	Product	OE Ref.No.
Tie rod end	CAM/ZF	SS309		1205658
Tie rod end left	TRW	SS905		2715985
Tie rod end right	TRW	SS906		2715993
Rack end	TRW	SS6048		9140788
Ball joint		SS907		2704773
Link rod		SS559		6819253
Bush trailing arm forward		SS5531		
Link rod rear		SS933		

VOLVO



XC70 CROSS COUNTRY 2.4 D5 AWD

12/05 -

SS2701 ◆

STEERING

SS2702 ◆

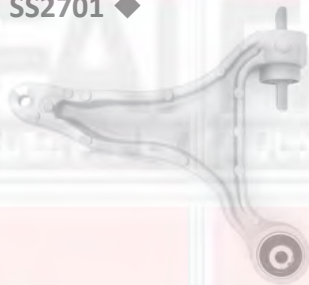

Description	Application	Part No	Product	OE Ref.No.
Wishbone Left		SS2701 ◆		30635231
Wishbone Right		SS2702 ◆		30635232

XC 90

06/02 -

STEERING

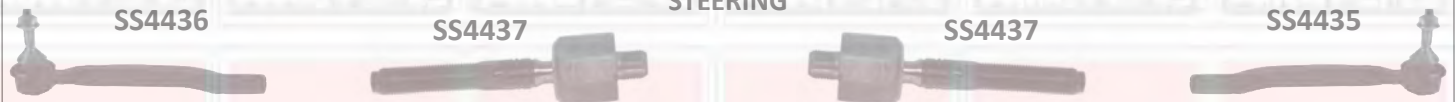

FRONT SUSPENSION



REAR SUSPENSION



Description	Application	Part No	Product	OE Ref.No.
Tie rod end right		SS4435		274499
Tie rod end left		SS4436		274498
Rack end		SS4437		274353
Wishbone left		SS6049		30639780
Wishbone right		SS6050		30639781
Ball joint		SS4438		274523
Wishbone front Bush		SS6051		30639368
Wishbone rear Bush		SS6052		30645847
Link rod		SS6053		30714685
Link rod		SS6054		30647920