

CITROEN



AX

01/87 - 97

STEERING

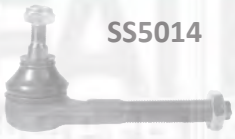

SS5014



SS1035



SS1035



SS5011

FRONT SUSPENSION



SS3041

SS916



SS916



SS3041



SS5034



SS5060



SS636



SS637

SS164



SS164



SS202



SS202



SS202



SS001



SS002

SS011



SS1242



SS1242



SS011



SS155

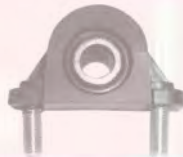

SS138



SS138



SS155



## CITROEN

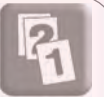

AX (continued)

01/87 - 97

Description	Application Notes	Part No	Product Notes	OE Ref.No.
Tie rod end inner	manual steering	<b>SS1035</b>		381732
Tie rod end left		<b>SS5014</b>		381714
Tie rod end right		<b>SS5011</b>		381716
Strut mount bearing only		<b>SS3041</b>		503518
Wishbone left	1986-1991 only	<b>SS5034</b>	14mm pin	95614999
Wishbone right	1986-1991 only	<b>SS5060</b>	14mm pin	95615000
Wishbone left	1991-1995 only exc GTi	<b>SS636</b>	16mm pin	95658978
Wishbone right	1991-1995 only exc GTi	<b>SS637</b>	16mm pin	95658979
Wishbone left	GTi only	<b>SS001</b>		352092
Wishbone right	GTi only	<b>SS002</b>		352093
Ball joint	1/87-7/91 only exc Gti	<b>SS164</b>	14mm pin	95603309
Ball joint	1991-1995 only -exc GTi	<b>SS202</b>	16mm pin	364036
Bush wishbone forward	exc Gti	<b>SS1242</b>		352350
Bush wishbone	91 - exc GTi	<b>SS011</b>		352351
Bush wishbone forward	Forward GTi only	<b>SS138</b>		352352
Bush wishbone forward	Rearward GTi only	<b>SS155</b>		352353
Link rod	GT/Gti	<b>SS916</b>		508733

CITROEN

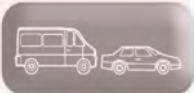

BERLINGO MULTISPACE

97 - 08

STEERING

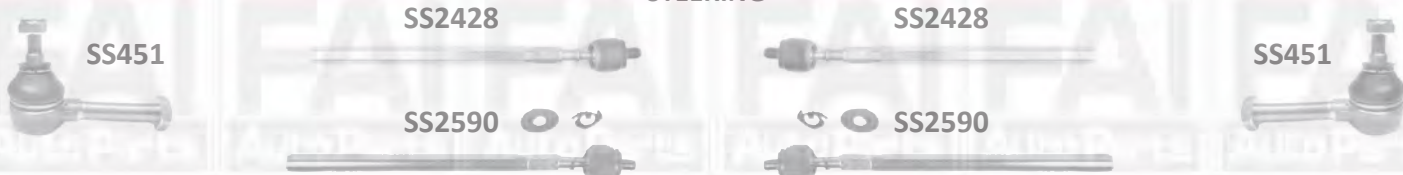

FRONT SUSPENSION

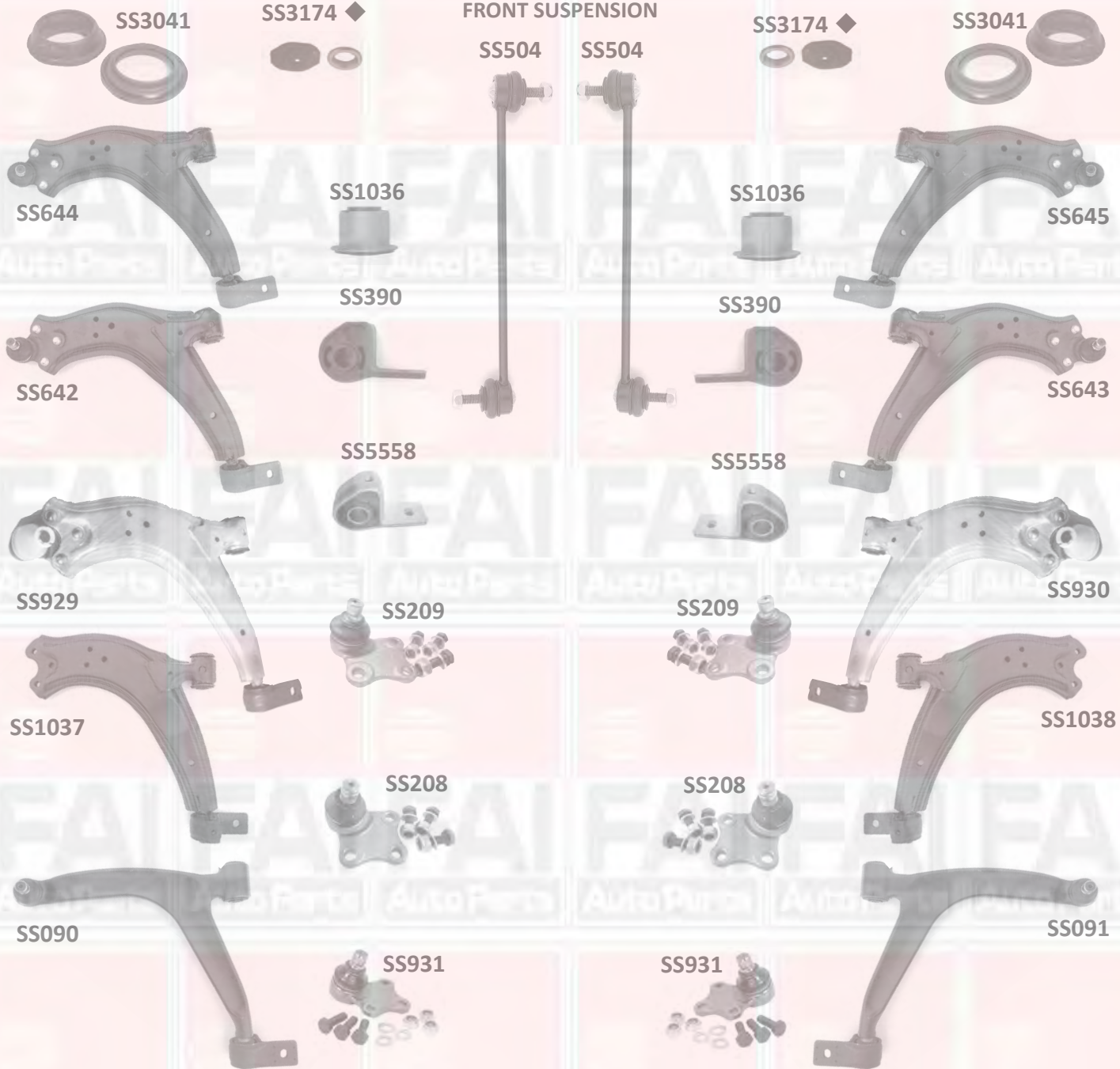

FRONT SUSPENSION

SS6323



SS6323



## CITROEN

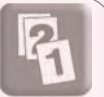

## BERLINGO MULTISPACE (continued)

97 - 08

Description	Application Notes	Part No	Product Notes	OE Ref.No.
Tie rod end		<b>SS451</b>		381709
Rack end	Hdi	<b>SS2428</b>		3812C6
Rack end	exc Hdi	<b>SS2590</b>		3812C0
Strut mount bearing		<b>SS3041</b>		503518
Strut mount	with power steering	<b>SS3174</b> ◆		503824
Wishbone left	-> 7972 with manual steering	<b>SS644</b>	16mm pin	352088
Wishbone right	-> 7972 with manual steering	<b>SS645</b>	16mm pin	3521C6
Wishbone left	-> 7972 with power steering	<b>SS642</b>	16mm pin	3520
Wishbone right	-> 7972 with power steering	<b>SS643</b>	16mm pin	352172
Wishbone left	7973 -> with power steering	<b>SS929</b>	18mm pin	3520H5
Wishbone right	7973 -> with power steering	<b>SS930</b>	18mm pin	3521E5
Wishbone left		<b>SS1037</b>		
Wishbone right		<b>SS1038</b>		
Wishbone left	2.0 Hdi only	<b>SS090</b>		3520H9
Wishbone right	2.0 Hdi only	<b>SS091</b>		3520J4
Ball joint	-> 7972 with manual steering	<b>SS209</b>	16mm pin	364039
Ball joint	-> 7972 with manual steering	<b>SS208</b>	16mm pin	364038
Ball joint	7973 -> with power steering exc 2.0 Hdi	<b>SS931</b>	18mm pin	364050
Bush wishbone forward		<b>SS1036</b>		352375
Bush wishbone rearward	exc 2.0 Hdi	<b>SS390</b>	Thread size 8mm	352362
Bush wishbone rearward	2.0 Hdi only	<b>SS5558</b>	Thread size 10mm	352383
Link rod		<b>SS504</b>		508746
Bush subframe rearward		<b>SS6323</b>		515262

CITROEN



BERLINGO MULTISPACE

06/08 -

STEERING

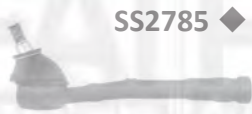

SS2785 ◆

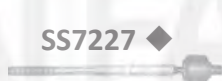

SS7227 ◆

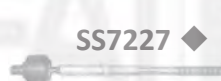

SS7227 ◆

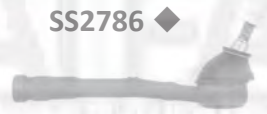

SS2786 ◆

FRONT SUSPENSION

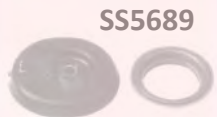

SS5689



SS1178



SS1237



SS7028 ◆



SS7028 ◆



SS5689



SS1179

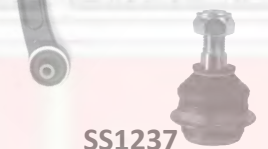

SS1237

Description	Application Notes	Part No	Product Notes	OE Ref.No.
Tie rod end left		SS2785 ◆		381776
Tie rod end right		SS2786 ◆		381775
Rack end		SS7227 ◆		3812.F4
Strut Mount		SS5689		
Wishbone left		SS1178		3521K8
Wishbone right		SS1179		3521G8
Ball joint		SS1237		364053
Front link rod		SS7028 ◆	Length - 335mm	5087

BX

01/82 - 05/93

STEERING



SS341

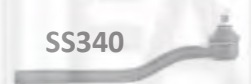

SS340

FRONT SUSPENSION



SS151

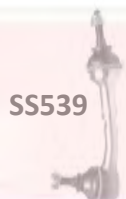

SS539

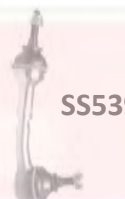

SS539



SS151

Description	Application Notes	Part No	Product Notes	OE Ref.No.
Tie rod end left		SS341		95495440
Tie rod end right		SS340		95496045
Ball joint		SS151	Thread length 38mm	36402
Link rod		SS539		95494820

CITROEN

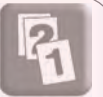

C1

05 -

STEERING



FRONT SUSPENSION



Description	Application Notes	Part No	Product Notes	OE Ref.No.
Tie rod end left		SS5687		381763
Tie rod end right		SS5688		381764
Rack end		SS7236 ◆		
Wishbone left		SS5684		3520Q2
Wishbone right		SS5685		3521L3
Bush wishbone forward		SS6284		
Bush wishbone rearward		SS6283		
Ball joint		SS7039 ◆		
Link rod		SS5686		509110

CITROEN

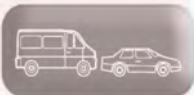

C2 04 -

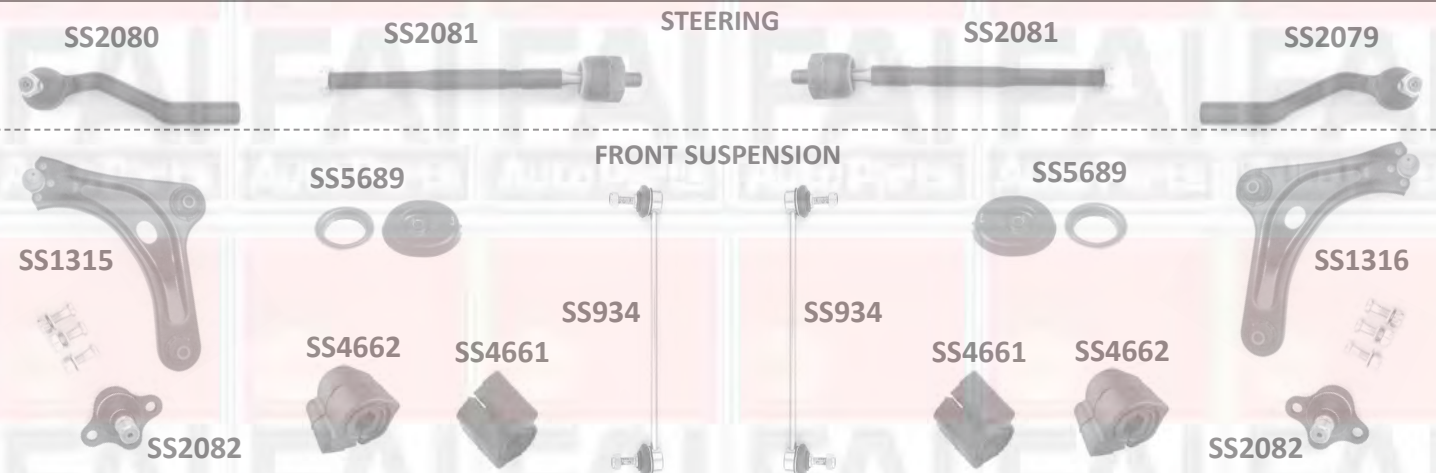

Description	Application Notes	Part No	Product Notes	OE Ref.No.
Tie rod end left		SS2080		381755
Tie rod end right		SS2079		381756
Rack end		SS2081		38120
Strut Mount		SS5689		
Wishbone left	exc HD Susp.	SS1315		3520L9
Wishbone right	exc HD Susp.	SS1316		3521J1
Ball joint		SS2082		364056
Bush anti roll bar	exc 1.6	SS4661	16mm	509497
Bush anti roll bar	1.6	SS4662	20mm	509496
Link rod		SS934		508745

C3 incl Pluriel 02 -

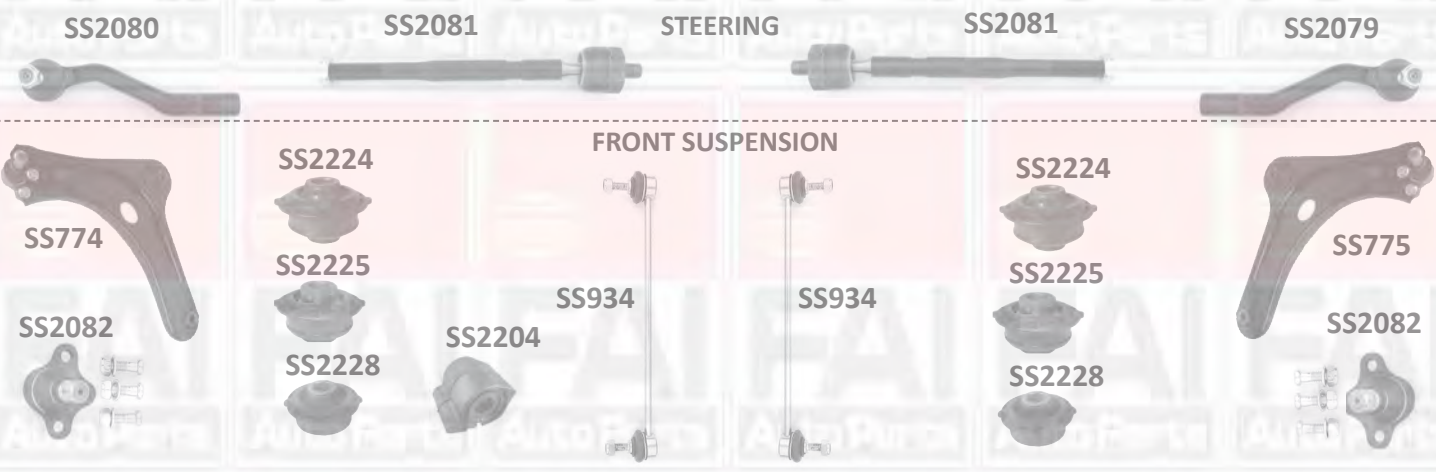

Description	Application Notes	Part No	Product Notes	OE Ref.No.
Tie rod end left		SS2080		381755
Tie rod end right		SS2079		381756
Rack end		SS2081		38120
Wishbone left		SS774		3520L4
Wishbone right		SS775		3521H6
Ball joint		SS2082		364056
Bush wishbone forward		SS2224		352398
Bush wishbone rearward		SS2225		3523AA
Bush wishbone rearward		SS2228		3523AT
Bush anti roll bar		SS2204	Dia - 19mm	509491
Link rod		SS934		508745

**CITROEN**

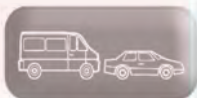

**C3** 09 -

**STEERING**

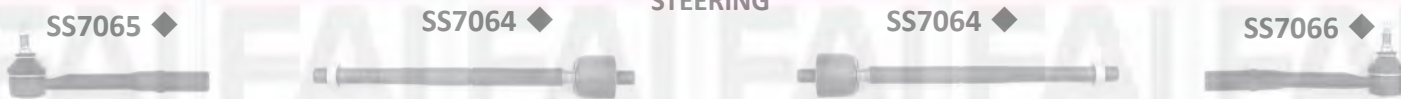

**FRONT SUSPENSION**

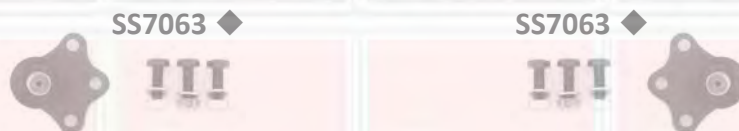

Description	Application Notes	Part No	Product Notes	OE Ref.No.
Tie rod end left		SS7065 ◆		381792
Tie rod end right		SS7066 ◆		381791
Rack end		SS7064 ◆		3812F6
Ball joint		SS7063 ◆		364077

**C3 PICASSO** 02/09 -

**STEERING**

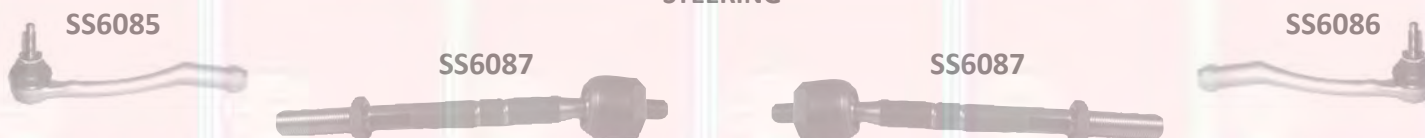

**FRONT SUSPENSION**

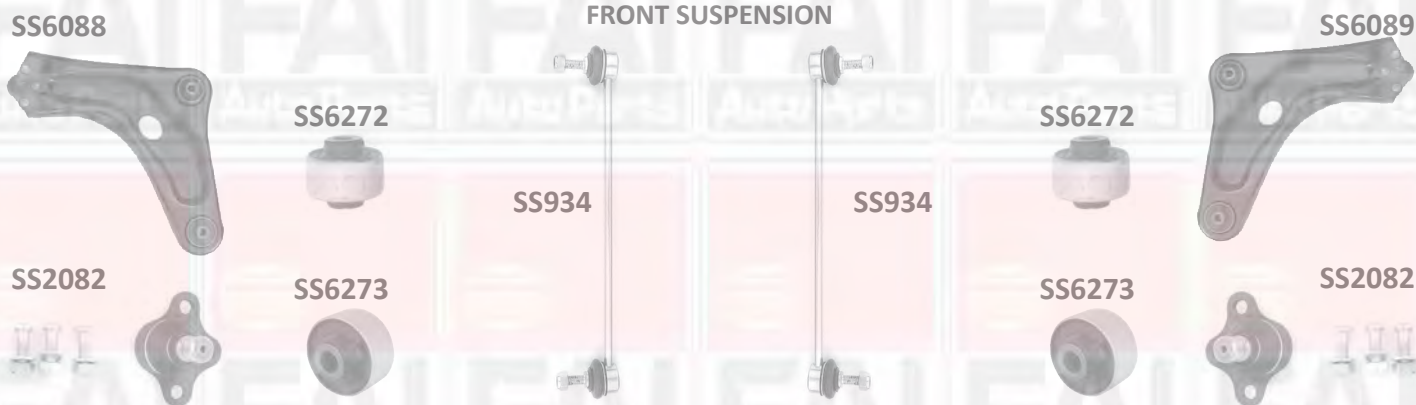

Description	Application Notes	Part No	Product Notes	OE Ref.No.
Tie rod end left		SS6085		381767
Tie rod end right		SS6086		381768
Rack end		SS6087		38120000000
Wishbone left		SS6088		
Wishbone right		SS6089		
Ball joint		SS2082		364056
Bush Wishbone forward		SS6272		
Bush Wishbone rearward		SS6273		
Link rod		SS934		508745

CITROEN

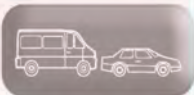

C4

04 -

STEERING



FRONT SUSPENSION

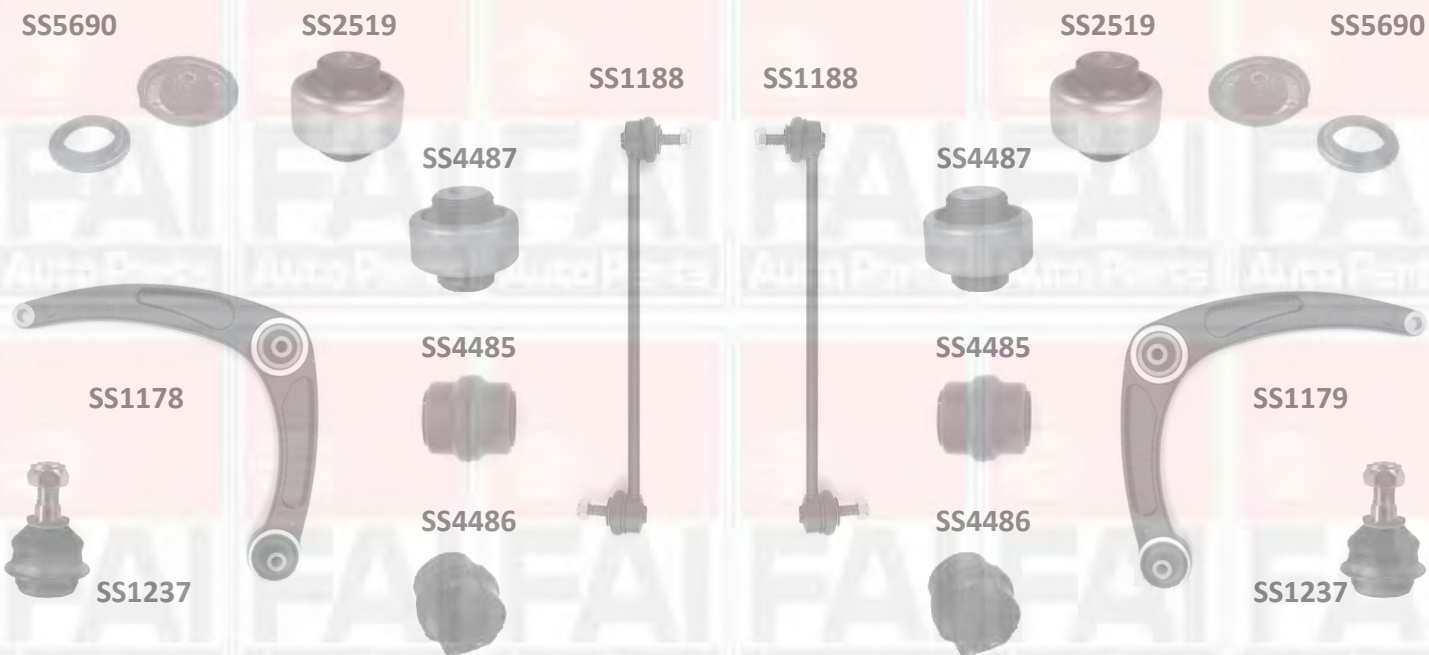

REAR SUSPENSION



Description	Application Notes	Part No	Product Notes	OE Ref.No.
Tie rod end left	-RP 10310	SS5011		381716
Tie rod end right	-RP 10310	SS5014		381714
Tie rod end	RP 10311-	SS451		381709
Rack end	-RP 10310	SS882		3812
Rack end	RP 10311-	SS6259		381200000
Strut Mount		SS5690		
Wishbone left		SS1178		3521K8
Wishbone right		SS1179		3521G8
Ball joint		SS1237		364053
Bush wishbone forward		SS2519		352391
Bush wishbone rearward		SS4487		352392
Bush anti roll bar		SS4485	Dia 21mm	509487
Bush anti roll bar		SS4486	Dia 22mm	509488
Link rod		SS1188		508750
Hub carrier bush		SS7201 ◆		5131A4

CITROEN

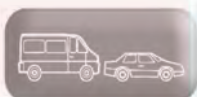

C4 GRAND PICASSO / C4 PICASSO

10/06 -

STEERING



FRONT SUSPENSION

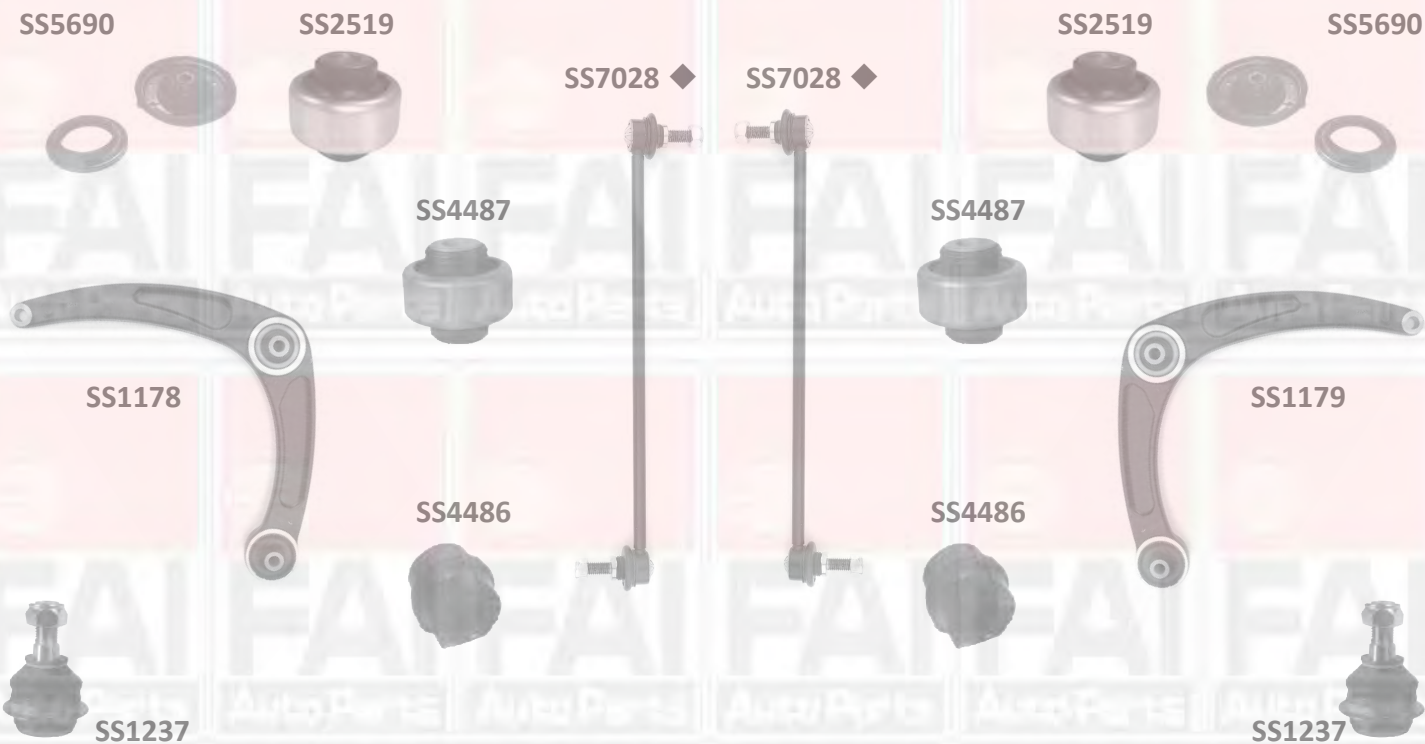

Description	Application Notes	Part No	Product Notes	OE Ref.No.
Tie rod end left		SS2828 ◆	Thread Size - M16 x 1.5	381771
Tie rod end right		SS2829 ◆	Thread Size - M16 x 1.5	381772
Rack end		SS2827 ◆	Thread Size - M14 x 1.5	508750
Strut Mount		SS5690		
Wishbone left		SS1178		3521K8
Wishbone right		SS1179		3521G8
Ball joint		SS1237		
Bush wishbone forward		SS2519		352391
Bush wishbone rearward		SS4487		352392
Bush anti roll bar		SS4486	Dia 22mm	509488
Front link rod		SS7028 ◆	length 335mm	5087.57

CITROEN

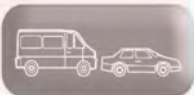

C5

10/00 - 08

STEERING

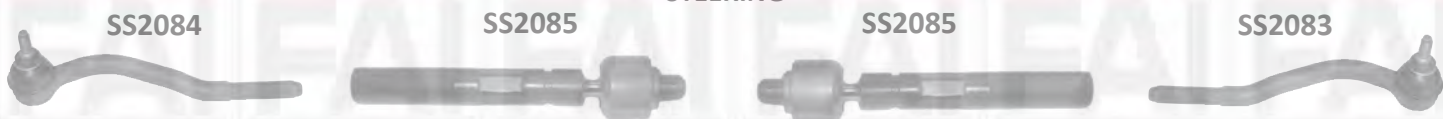

FRONT SUSPENSION



Description	Application Notes	Part No	Product Notes	OE Ref.No.
Tie rod end left		SS2084		381753
Tie rod end right		SS2083		381754
Rack end		SS2085		3812C8
Wishbone left		SS2086		3521G3
Wishbone right		SS2087		3520K3
Ball joint		SS524	Thread length 40mm	364028
Bush anti roll bar outer		SS2202	Dia 23.5mm	509483
Bush wishbone forward		SS4287		352384
Bush wishbone rearward		SS4314		352395
Link rod		SS935		308748

C5

08 -



REAR SUSPENSION



Description	Application Notes	Part No	Product Notes	OE Ref.No.
Ball joint upper		SS2385		3640.57
Ball joint lower		SS5906		
Link rod left		SS2387		508753
Link rod right		SS2386		508752
Link rod rear		SS5907		517846

**CITROEN**

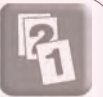

C6

06 -

**STEERING**



**FRONT SUSPENSION**

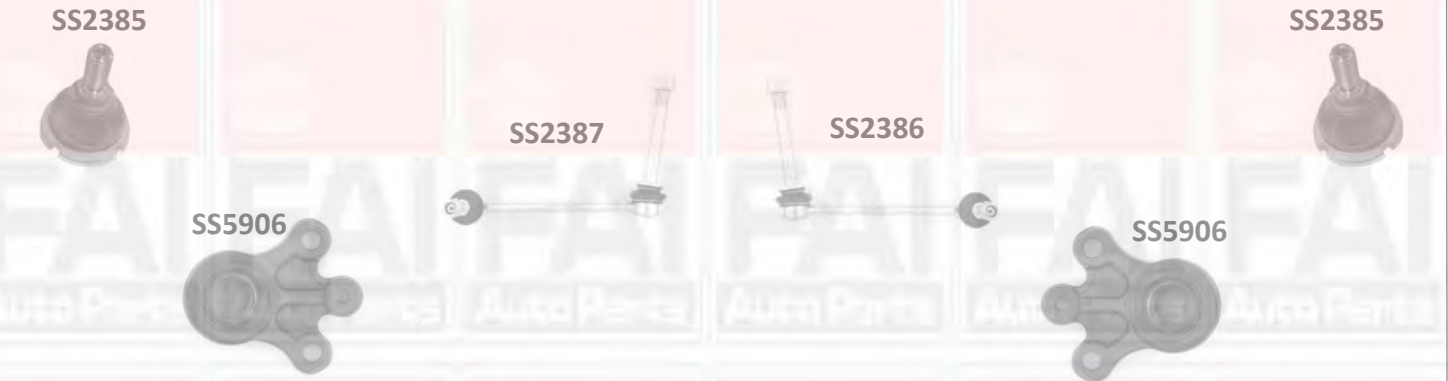

**REAR SUSPENSION**



Description	Application Notes	Part No	Product Notes	OE Ref.No.
Tie rod end left		SS4219		381758
Tie rod end right		SS4218		381757
Rack end		SS2384		3817B3
Ball joint upper		SS2385		3640.57
Ball joint lower		SS5906		
Link rod left		SS2387		508753
Link rod right		SS2386		508752
Link rod rear		SS5907		517846

CITROEN

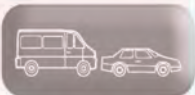

C8

01/02 -

STEERING



SS2418

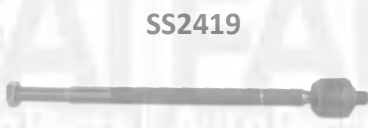

SS2419

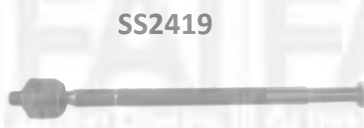

SS2419

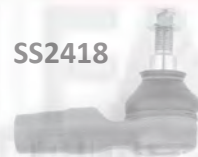

SS2418

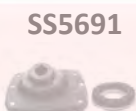

SS5691

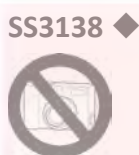

SS3138 ◆

FRONT SUSPENSION

SS2403



SS2403

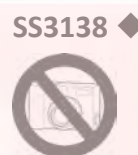

SS3138 ◆



SS5692



SS2452

SS4736



SS2453

SS4735



Description	Application Notes	Part No	Product Notes	OE Ref.No.
Tie rod end		SS2418		405912
Rack end		SS2419		3812E2
Strut Mount left		SS5691		
Strut Mount right		SS5692		
Strut bearing		SS3138 ◆		
Wishbone left		SS2452		3521H0
Wishbone right		SS2453		3521H1
Bush wishbone rearward left		SS4736		
Bush wishbone rearward right		SS4735		
Link rod		SS2403		5081F1

CITROEN

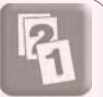

EVASION

95 - 03

STEERING



SS3138 ◆

FRONT SUSPENSION

SS3138 ◆



REAR SUSPENSION

SS4674

SS4674



Description	Application Notes	Part No	Product Notes	OE Ref.No.
Tie rod end		SS646		1306003080
Rack end		SS094		3812A4
Strut mount with bearing		SS3138 ◆		
Wishbone left	exc 2.0 Hdi	SS647		1313083080
Wishbone right	exc 2.0 Hdi	SS648		1313084080
Bush wishbone forward		SS095		1312317080
Bush wishbone rearward left		SS096		1305551080
Bush wishbone rearward right		SS097		1305552080
Link rod		SS467		508735
Bush trailing arm rear		SS4674		

CITROEN

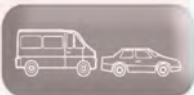

C-CROSSER

09/07 -

STEERING



FRONT SUSPENSION



REAR SUSPENSION



Description	Application Notes	Part No	Product Notes	OE Ref.No.
Tie rod end		SS2854 ◆	M14 x 1.5	381774
Rack end		SS7035 ◆	L - 335mm M14 x 1.5	3812 F1
Front link rod		SS7067 ◆	L - 265mm M10 x 1.25	508758
Link rod-rear-left		SS2856 ◆	M10 x 1.25	517848
Link rod-rear-right		SS2857 ◆	M10 x 1.25	517849



CITROEN

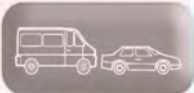

SAXO

02/96 - 04

STEERING



SS5014



SS4056

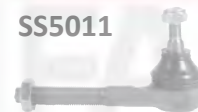

SS5011



SS5546



SS4672



SS4673

FRONT SUSPENSION



SS5899



SS3041



SS202



SS916



SS916



SS202



SS3041



SS5899



SS3039



SS3039



SS636



SS1242



SS1242



SS637

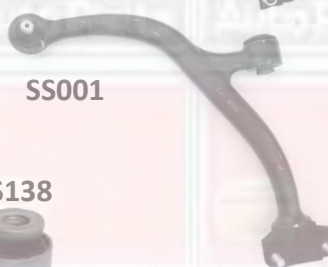

SS001



SS011



SS525



SS525



SS011

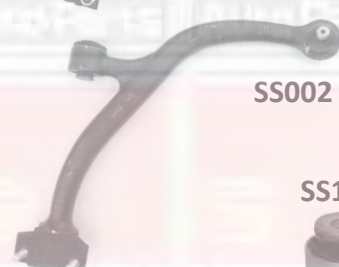

SS002



SS138



SS138

SS2181



SS155



SS155

SS2181

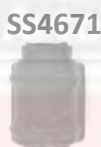

SS4671

SS2187



SS2188



SS4669

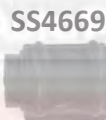

SS4669

SS2188



SS2187

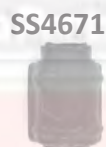

SS4671

REAR SUSPENSION

SS5694



SS5693



SS5693



SS5694



## CITROEN



## SAXO (continued)

02/96 - 04

Description	Application Notes	Part No	Product Notes	OE Ref.No.
Tie rod end		<b>SS5014</b>	thread length 14mm	381714
Tie rod end		<b>SS5011</b>	thread length 14mm	381716
Tie rod end inner	man. strg. rhd rp. 7252- man. strg. lhd rp. 7245 - PAS lhd/rhd	<b>SS4056</b>		381747
Tie rod end	man. strg. rhd -rp.7251	<b>SS4672</b>		381735
Tie rod end inner	man. strg. rhd -rp7251	<b>SS5546</b>		381733
Tie rod inner	PAS lhd -rp7083	<b>SS4673</b>		381736
Tie rod end inner	PAS lhd -rp7083	<b>SS5546</b>		381733
Strut mount		<b>SS5899</b>	Two bolt type	
Strut mount with bearing		<b>SS3039</b>	three bolt type	503815
Strut mount bearing only		<b>SS3041</b>		503518
Wishbone left	exc VTR/VTS	<b>SS636</b>		95658978
Wishbone right	exc VTR/VTS	<b>SS637</b>		95658979
Wishbone left	VTR/VTS only	<b>SS001</b>		352092
Wishbone right	VTR/VTS only	<b>SS002</b>		352093
Ball joint	exc VTR/VTS	<b>SS202</b>	16mm pin	364036
Bush wishbone forward	exc VTR/VTS	<b>SS1242</b>		352350
Bush wishbone	exc VTR/VTS	<b>SS011</b>		352351
Bush wishbone forward	VTR/VTS only	<b>SS138</b>		352352
Bush wishbone forward	VTR/VTS only	<b>SS155</b>		352353
Link rod	exc VTR/VTS	<b>SS525</b>	Thread length 12mm	50874
Link rod	VTR/VTS only	<b>SS916</b>		508733
Bush anti roll bar		<b>SS4671</b>	Dia 16mm	509476
Bush anti roll bar inner		<b>SS2181</b>	Dia 19mm	509456
Bush anti roll bar outer	exc TU5JP.J4	<b>SS2187</b>	dia 19mm	509459
Bush anti roll bar outer	exc TU5JP.J4	<b>SS2188</b>	Dia - 21mm	509460
Bush anti roll bar		<b>SS4669</b>	Dia 22mm	509471
Suspension arm Repair kit	without rear anti roll bar	<b>SS5694</b>		
Suspension arm Repair kit	with rear anti roll bar	<b>SS5693</b>		

CITROEN

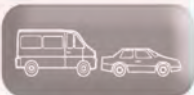

SYNERGIE

95 -

STEERING



FRONT SUSPENSION

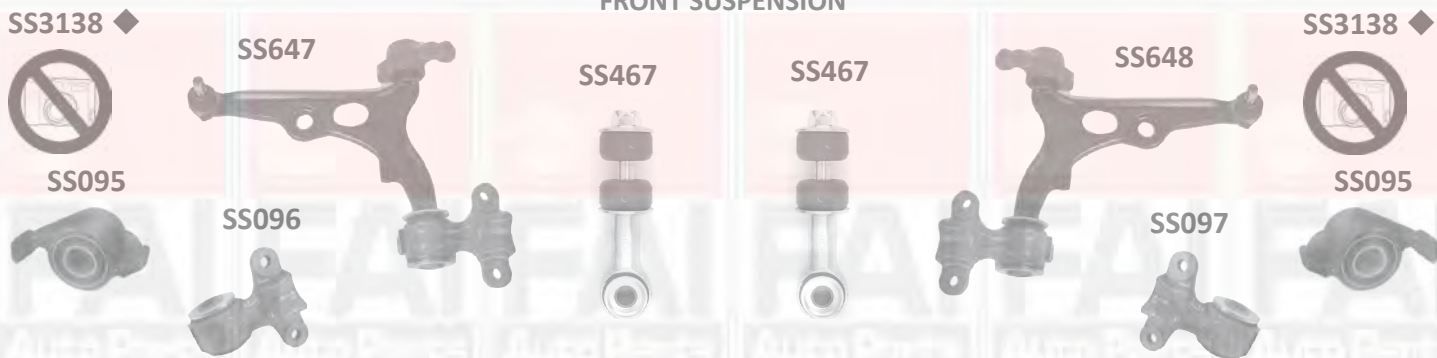

REAR SUSPENSION



Description	Application Notes	Part No	Product Notes	OE Ref.No.
Tie rod end		SS646		1306003080
Rack end		SS094		3812A4
Strut mount with bearing		SS3138 ♦		
Wishbone left	exc 2.0 Hdi	SS647		1313083080
Wishbone right	exc 2.0 Hdi	SS648		1313084080
Bush wishbone forward		SS095		1312317080
Bush wishbone rearward left		SS096		1305551080
Bush wishbone rearward right		SS097		1305552080
Link rod		SS467		508735
Bush trailing arm rear		SS4674		

VISA

01/79 - 12/88

STEERING

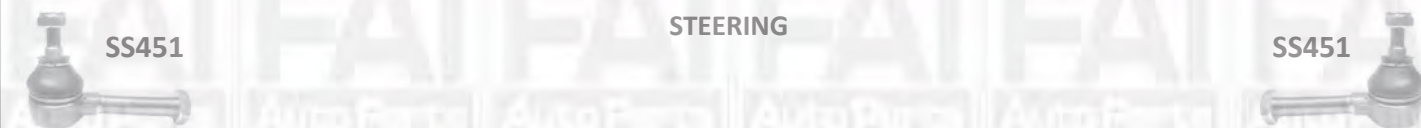

FRONT SUSPENSION



Description	Application Notes	Part No	Product Notes	OE Ref.No.
Tie rod end		SS451		381709
Wishbone left	Diesel only	SS233		352050
Wishbone right	Diesel only	SS232		352133
Wishbone left	GTI only	SS247		352054
Wishbone right	GTI only	SS248		352137

CITROEN

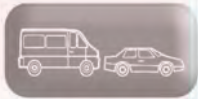

XANTIA

04/93 - 01

STEERING



FRONT SUSPENSION

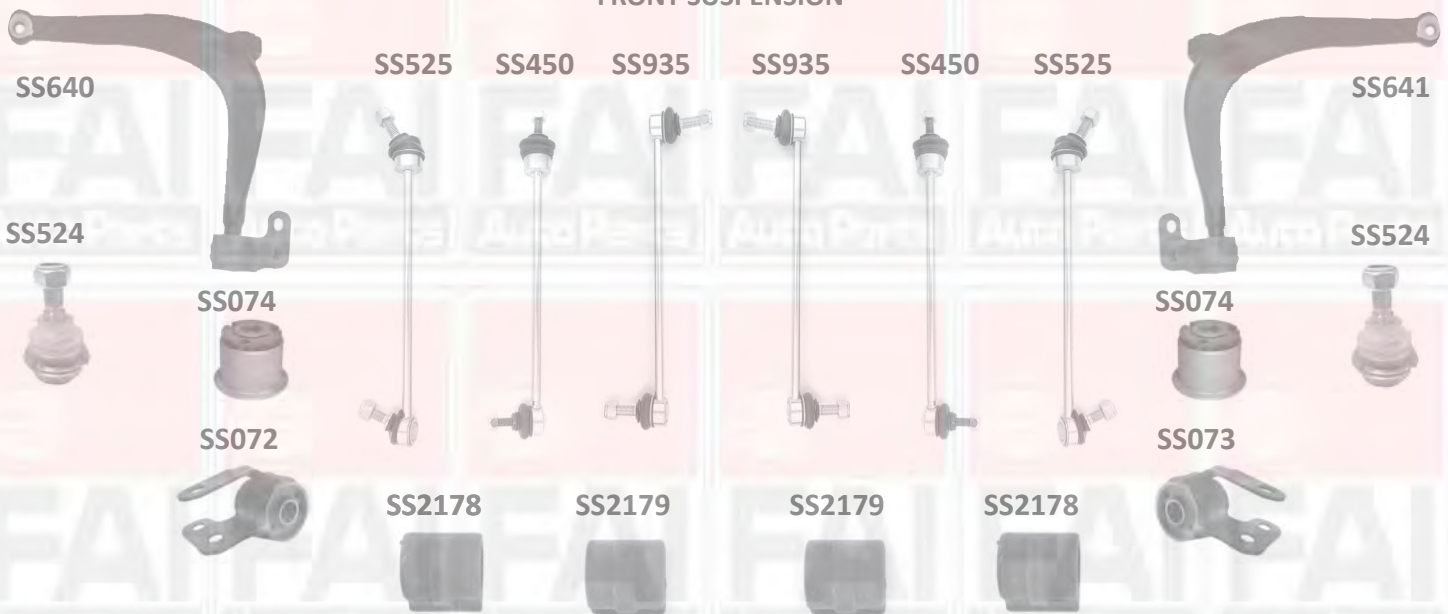

Description	Application Notes	Part No	Product Notes	OE Ref.No.
Tie rod end	exc turbo	<b>SS5014</b>	Thread - 14mm	381714
Tie rod end	exc turbo	<b>SS5011</b>	Thread - 14mm	381716
Tie rod end left	Turbo only	<b>SS4223</b>	Thread - 16mm	381743
Tie rod end right	Turbo only	<b>SS4222</b>	Thread - 16mm	381744
Rack end	Turbo only	<b>SS2383</b>	Length 331mm	96136394
Rack end	exc turbo	<b>SS092</b>		381295
Wishbone left		<b>SS640</b>		352086
Wishbone right		<b>SS641</b>		352158
Ball joint		<b>SS524</b>	Thread - 40mm	364028
Bush wishbone forward		<b>SS074</b>		96083570
Bush wishbone rearward left		<b>SS072</b>		352381
Bush wishbone rearward right		<b>SS073</b>		352381
Link rod	7/93-12/94only	<b>SS450</b>	10mm ThreadS	96145457
Link rod	12/94 - 99	<b>SS525</b>	12mm ThreadS	50874
Link rod	99 - 01	<b>SS935</b>		308748
Bush anti roll bar outer		<b>SS2178</b>	Dia 22mm	96089104
Bush anti roll bar outer		<b>SS2179</b>	Dia 23mm	96089106

CITROEN

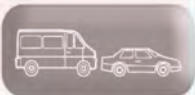

XM

10/89 - 10/00

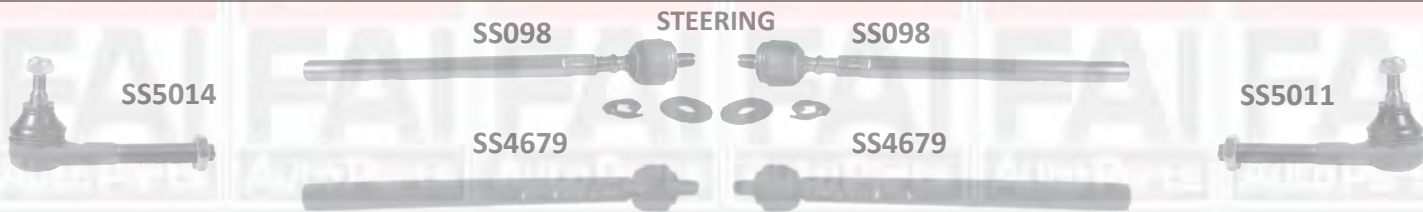

FRONT SUSPENSION

SS524



SS135



SS135



SS524



Description	Application Notes	Part No	Product Notes	OE Ref.No.
Tie rod end left		SS5014		381714
Tie rod end right		SS5011		381716
rack end		SS098	18mm Thread	381299
Rack end		SS4679	22mm Thread	3812A6
Ball joint		SS524		364028
Link rod		SS135		508730

CITROEN



XSARA

97 -

STEERING



FRONT SUSPENSION



Description	Application Notes	Part No	Product Notes	OE Ref.No.
Tie rod end		SS451		381709
Rack end		SS2590		3812C0
Strut mount with bearing	*	SS3043		503539
Strut mount with bearing	**	SS3044		503822
Wishbone left	manual steering	SS644		3520G4
Wishbone right	manual steering	SS645		3521C6
Wishbone left	-> 7972 - PAS -1999	SS642	16mm pin	3520
Wishbone right	-> 7972 - PAS -1999	SS643	16mm pin	352172
Wishbone left	7973 -> PAS only 1999-	SS929	18mm pin	3520H5
Wishbone right	7973 ->PAS only 1999-	SS930	18mm pin	3521E5
Wishbone left		SS1037	without ball joint	
Wishbone right		SS1038	without ball joint	
Ball joint	-> 7972 PAS -1999	SS208	16mm pin	364038
Ball joint	7973 ->PAS only 1999-	SS931	18mm pin	364050
Bush wishbone forward		SS1036		352375
Bush wishbone rearward		SS390	8mm thread	352362
Link rod		SS504		508746

\* 1.6 Coupe/Saloon (exc. heavy duty suspension), 1.8 Auto Coupe, 1.8 Saloon/Coupe (including 16V) 1.8/1.9 D/TD, 2.0 16V. Engs. TU5JP, XU7JP, XU7JB, XU7JP4, XUD7, XUD9BSD, XUD9A, XUD9TE, XU10J4R, XU10J4RS

\*\* 1.4 Saloon exc. heavy duty suspension Eng. TU3JP, 1.6 Coupe/Saloon (exc. heavy duty suspension), 1.8 Auto Coupe, 1.8 Saloon (including 16V) 1.8/1.9 D/TD, 2.0 16V. Engs. TU5JP, XU7JP, XU7JB, XU7JP4, XUD7, XUD9BSD, XUD9A, XUD9TE, XU10J4R, XU10J4RS

CITROEN

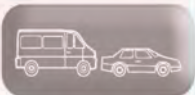

XSARA PICASSO

06/00 -

STEERING



SS451

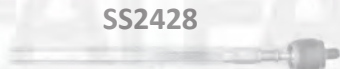

SS2428

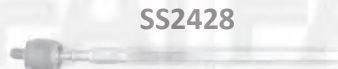

SS2428



SS451

SS090



FRONT SUSPENSION

SS504

SS504

SS091



SS929

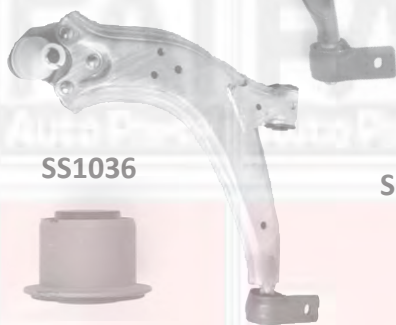

SS930



SS1036



SS501



SS501



SS1036



SS5558



SS5558



REAR SUSPENSION

SS4685



SS6323



SS6323



SS4685



Description	Application Notes	Part No	Product Notes	OE Ref.No.
Tie rod end		SS451		381709
Rack end		SS2428		3812C6
Wishbone left	std / HD susp. DAM09063FV	SS090	Cast type	3520H9
Wishbone right	std / HD susp. DAM09063FV	SS091	Cast type	3520J4
Wishbone left	std susp. DAM09063FV, DAM11249CJ -	SS929	18mm pin - Pressed type	3520H5
Wishbone right	std susp. DAM09063FV, DAM11249CJ -	SS930	18mm pin - Pressed type	3521E5
Bush wishbone forward		SS1036		352375
Bush wishbone		SS5558	thread size 10mm	352383
Link rod		SS504	Metal	508746
Link rod		SS501	plastic	508734
Bush subframe rear forward		SS4685		513147
Bush subframe rearward		SS6323		515262

# CITROEN

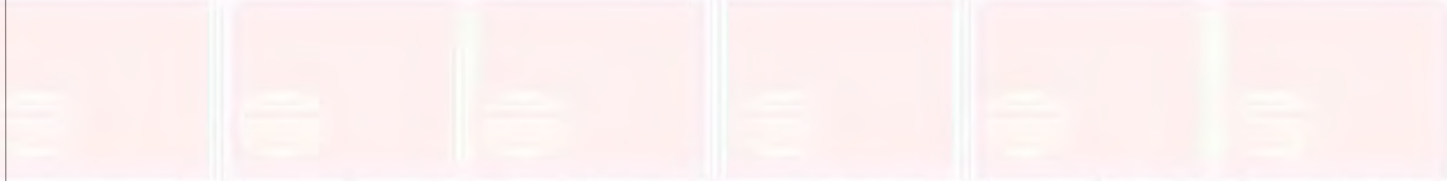
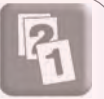

CITROEN

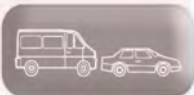

ZX

03/91 - 02/98

STEERING



SS451

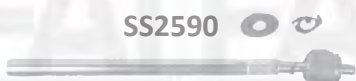

SS2590

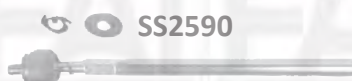

SS2590

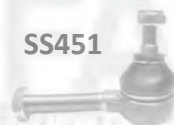

SS451

FRONT SUSPENSION



SS3043



SS3044

SS504

SS504

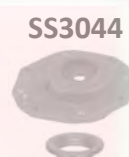

SS3044



SS3043



SS644



SS1036

SS390



SS1036

SS390



SS645



SS642



SS643



SS1037

SS501

SS501



SS209



SS1038



SS209



SS208



SS208

REAR SUSPENSION

SS471



SS2572



SS2573



SS471



## CITROEN

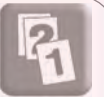

## ZX (continued)

Description	Application Notes	Part No	Product Notes	OE Ref.No.
Tie rod end		<b>SS451</b>		381709
Rack end		<b>SS2590</b>		3812C0
Strut mount with bearing	Power steering	<b>SS3043</b>		503539
Strut mount with bearing	Manual steering	<b>SS3044</b>		503822
Wishbone left	Manual steering	<b>SS644</b>		352088
Wishbone right	Manual steering	<b>SS645</b>		3521C6
Wishbone left	Power steering	<b>SS642</b>		3520
Wishbone right	Power steering	<b>SS643</b>		352172
Wishbone left		<b>SS1037</b>		
Wishbone right		<b>SS1038</b>		
Ball joint	Manual steering	<b>SS209</b>		364039
Ball joint	Power steering	<b>SS208</b>		364038
Bush wishbone forward		<b>SS1036</b>		352375
Bush wishbone rearward		<b>SS390</b>	Thread Size - 8mm	352362
Link rod	5684 ->	<b>SS504</b>	Metal	508746
Link rod	5684 ->	<b>SS501</b>	Plastic	508734
Mounting subframe rear forward		<b>SS471</b>		513171
Mounting subframe rear left		<b>SS2572</b>		513169
Mounting subframe rear right		<b>SS2573</b>		513170

CITROEN COMMERCIAL

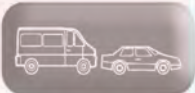

BERLINGO VAN

97 -

STEERING



SS451

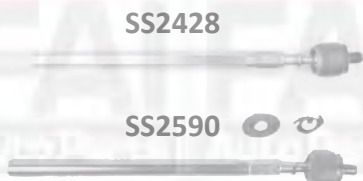

SS2428

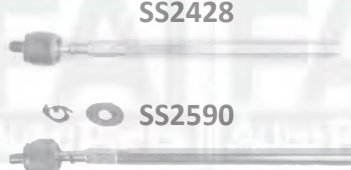

SS2428



SS451

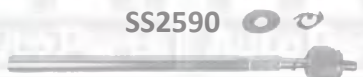

SS2590

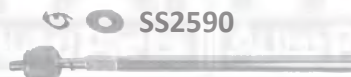

SS2590

FRONT SUSPENSION



SS3041

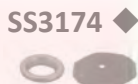

SS3174

SS504

SS504

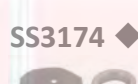

SS3174



SS3041



SS644



SS1036



SS1036



SS645



SS642



SS390

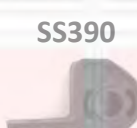

SS390



SS643



SS929



SS5558

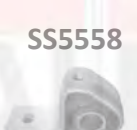

SS5558



SS930



SS1037



SS209



SS209



SS1038



SS090



SS208



SS208

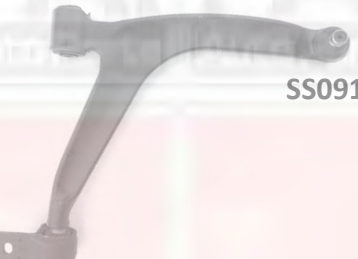

SS091



SS931



SS931

FRONT SUSPENSION

SS6323



SS6323



## CITROEN COMMERCIAL



## BERLINGO VAN (continued)

Description	Application Notes	Part No	Product Notes	OE Ref.No.
Tie rod end		<b>SS451</b>		381709
Rack end	Hdi	<b>SS2428</b>		3812C6
Rack end	exc Hdi	<b>SS2590</b>		3812C0
Strut mount bearing only		<b>SS3041</b>		503518
Strut mount	with power steering	<b>SS3174</b> ◆		503824
Wishbone left	-> 7972 with manual steering	<b>SS644</b>	16mm pin	352088
Wishbone right	-> 7972 with manual steering	<b>SS645</b>	16mm pin	3521C6
Wishbone left	-> 7972 with power steering	<b>SS642</b>	16mm pin	3520
Wishbone right	-> 7972 with power steering	<b>SS643</b>	16mm pin	352172
Wishbone left	7973 -> with power steering	<b>SS929</b>	18mm pin	3520H5
Wishbone right	7973 -> with power steering	<b>SS930</b>	18mm pin	3521E5
Wishbone left		<b>SS1037</b>		
Wishbone right		<b>SS1038</b>		
Wishbone left	2.0 Hdi only	<b>SS090</b>		3520H9
Wishbone right	2.0 Hdi only	<b>SS091</b>		3520J4
Ball joint	-> 7972 with manual steering	<b>SS209</b>	16mm pin	364039
Ball joint	-> 7972 with manual steering	<b>SS208</b>	16mm pin	364038
Ball joint	7973 -> with power steering exc 2.0 Hdi	<b>SS931</b>	18mm pin	364050
Bush wishbone forward		<b>SS1036</b>		352375
Bush wishbone rearward	exc 2.0 Hdi	<b>SS390</b>	Thread size 8mm	352362
Bush wishbone	2.0 Hdi only	<b>SS5558</b>	Thread size 10mm	352383
Link rod		<b>SS504</b>		508746
Bush subframe rearward		<b>SS6323</b>		515262

CITROEN COMMERCIAL

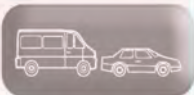

BERLINGO VAN

08 -

STEERING

SS2785 ◆

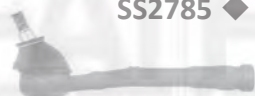

SS7227 ◆



SS7227 ◆

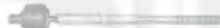

SS2786 ◆



FRONT SUSPENSION

SS5689

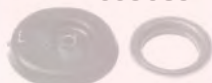

SS5689

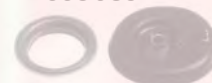

SS1178



SS7028 ◆



SS7028 ◆



SS1179



SS1237



SS1237



Description	Application Notes	Part No	Product Notes	OE Ref.No.
Tie rod end Left		SS2785 ◆		381776
Tie rod end Right		SS2786 ◆		381775
Rack end		SS7227		3812.F4
Strut Mount		SS5689		
Wishbone left		SS1178		3521K8
Wishbone right		SS1179		3521G8
Ball joint		SS1237		364053
Front link rod		SS7028 ◆	Length - 335mm	5087.57

**CITROEN COMMERCIAL**

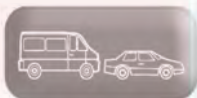

**C15** **06/85 -**

**STEERING**



**FRONT SUSPENSION**

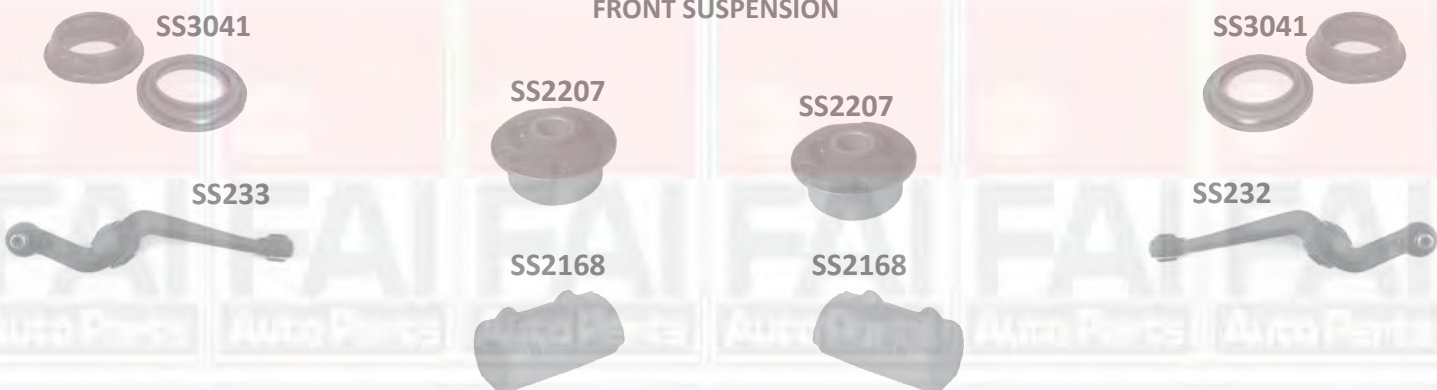

Description	Application Notes	Part No	Product Notes	OE Ref.No.
Tie rod end		SS451		381709
Rack end		SS092		381295
Strut mount bearing only		SS3041		503518
Wishbone left	Diesel only	SS233		352050
Wishbone right	Diesel only	SS232		352133
Bush wishbone outer		SS2207		352349
Bush anti roll bar	600kg models	SS2168	Dia - 23mm	509440

**C25 BOX** **04/87 - 06/94**

**STEERING**



**FRONT SUSPENSION**



Description	Application Notes	Part No	Product Notes	OE Ref.No.
Tie rod end		SS343		381711
Ball joint		SS181	19.5mm pin	3640.26

CITROEN COMMERCIAL

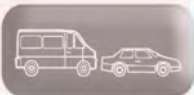

DISPATCH / JUMPY

08/96 - 11/06

STEERING



FRONT SUSPENSION

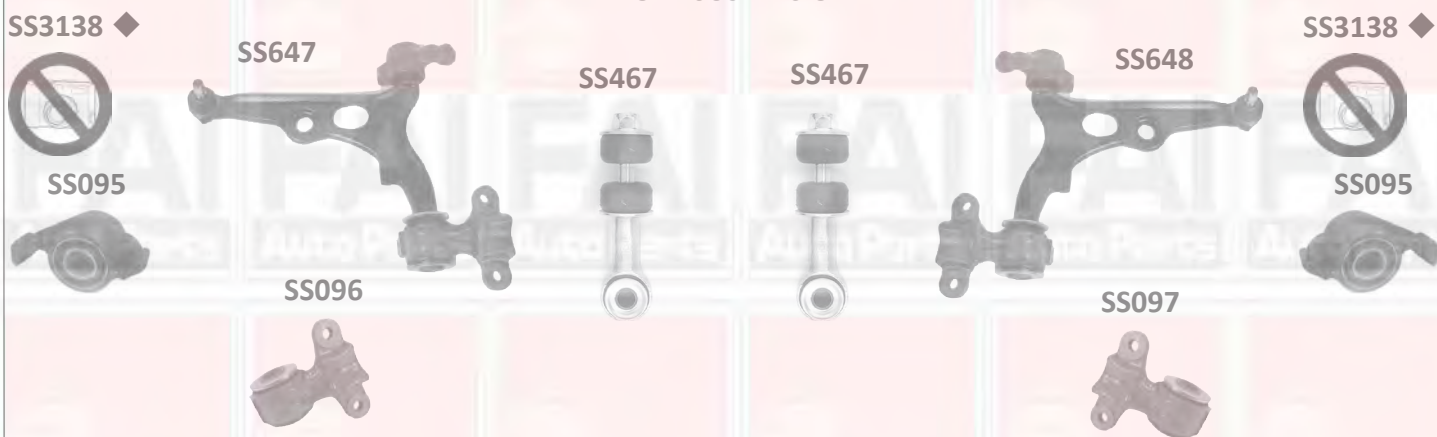

Description	Application Notes	Part No	Product Notes	OE Ref.No.
Tie rod end	10/95-08/03	SS646		1306003080
Tie rod end	09/03-	SS5721		77362279
Rack end	10/95-08/03	SS094		3812A4
Rack end	09/03-	SS2418		405912
Strut mount with bearing		SS3138 ◆		
Wishbone left		SS647		1313083080
Wishbone right		SS648		1313084080
Bush wishbone forward		SS095		1312317080
Bush wishbone rearward left		SS096		1305551080
Bush wishbone rearward right		SS097		1305552080
Link rod		SS467		508735

**CITROEN COMMERCIAL**

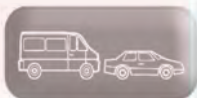

DISPATCH

11/06 -

STEERING

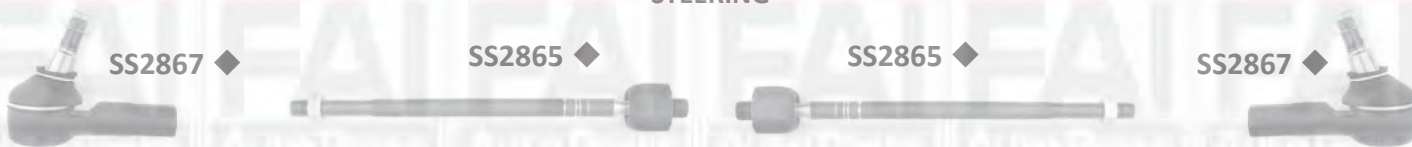

FRONT SUSPENSION



Description	Application Notes	Part No	Product Notes	OE Ref.No.
Tie rod end		SS2867 ◆		381773
Rack end		SS2865 ◆		3812FO
Wishbone Left		SS2705 ◆		3520R8
Wishbone Right		SS2706 ◆		3521N9
Bush wishbone rearward left		SS4736		
Bush wishbone rearward right		SS4735		
Front Link rod		SS2830 ◆		508756

NEMO

11/07 -

STEERING



FRONT SUSPENSION



Description	Application Notes	Part No	Product Notes	OE Ref.No.
Tie rod left		SS2868 ◆	Thread Size - M14 x 1.5	381784
Tie rod right		SS2869 ◆	Thread Size - M14 x 1.5	381785
Rack end		SS7046 ◆		
Wishbone left		SS5716		55703629
Wishbone right		SS5717		55703627
Ball joint		SS5711		
wishbone bush forward		SS2615 ◆		
wishbone bush rearward		SS5719		
Front Link rod		SS2831 ◆		508765

CITROEN COMMERCIAL

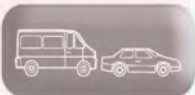

RELAY / JUMPER

06/94 - 02

STEERING

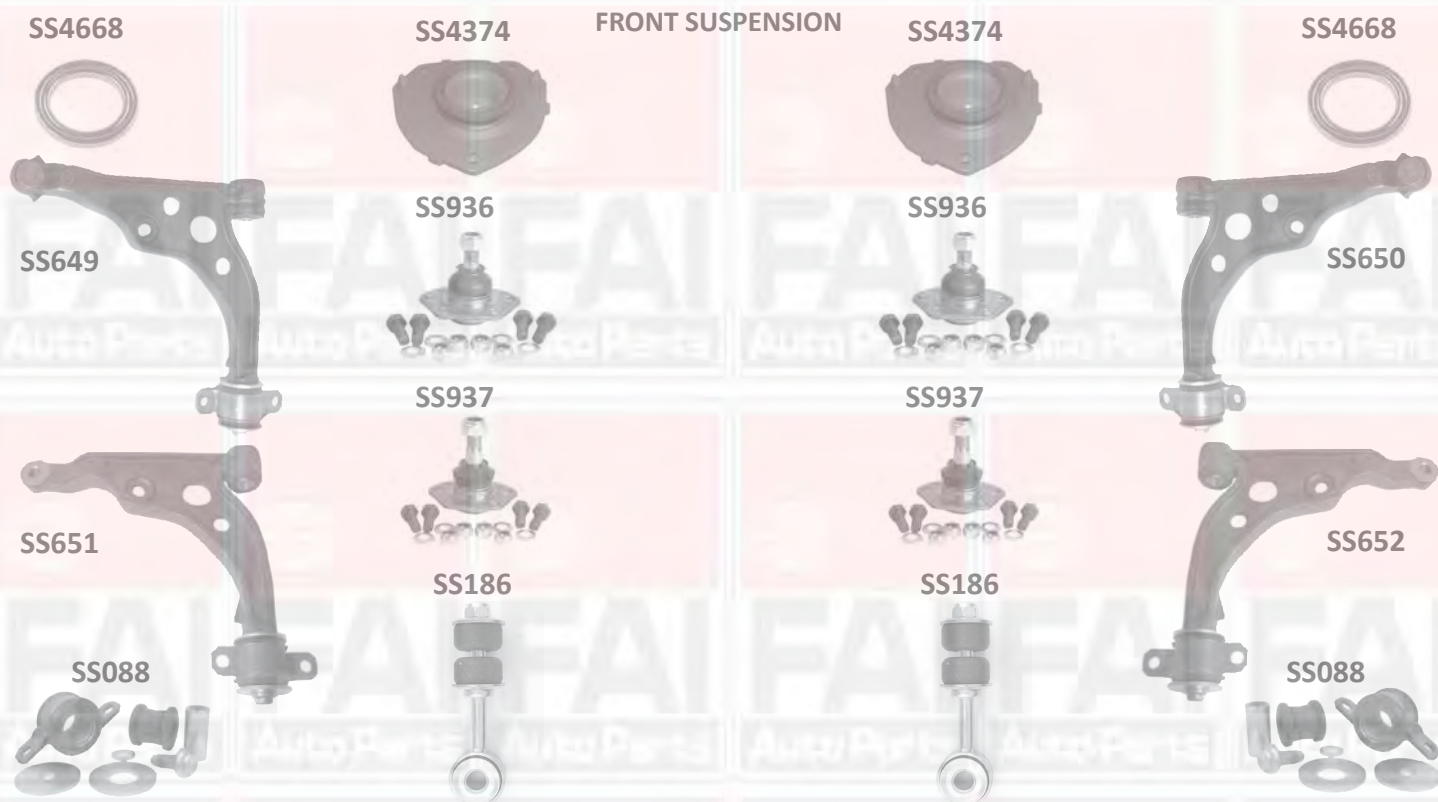
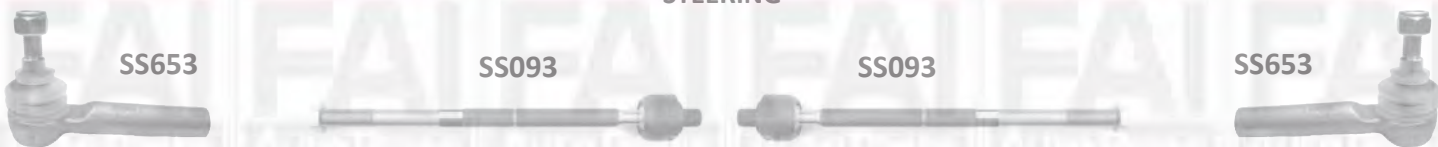

REAR SUSPENSION

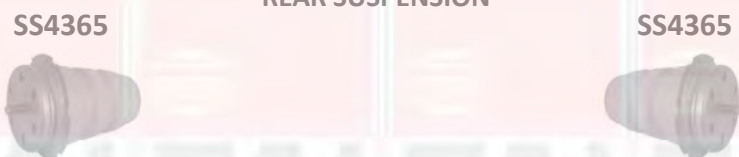

Description	Application Notes	Part No	Product Notes	OE Ref.No.
Tie rod end		SS653		1306716080
Rack end		SS093		4018A4
Strut mount bearing only		SS4668		503547
Strut mount left		SS4374	without bearing	503818
Strut mount right		SS4373	without bearing	503819
Wishbone left	1000/1400kg	SS649		1302369080
Wishbone right	1000/1400kg	SS650		1302372080
Wishbone left	1800kg	SS651		1308759080
Wishbone right	1800kg	SS652		1308760080
Ball joint	1000/1400kg	SS936	16mm pin	1302368080
Ball joint	1800kg	SS937	18mm pin	1300473080
Kit wishbone repair		SS088		
Link rod		SS186		508737
Mounting rear axle		SS4365		1311858080

**CITROEN COMMERCIAL**

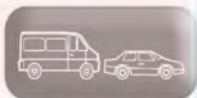

**RELAY / JUMPER**

02 - 06

**STEERING**



**FRONT SUSPENSION**



**REAR SUSPENSION**



Description	Application Notes	Part No	Product Notes	OE Ref.No.
Tie rod end	04/02-	SS4225		
Tie rod end	12/02-	SS653		1306716080
Rack end		SS093		
Strut mount bearing		SS3102 ◆		
Wishbone left	1400kg	SS5560		
Wishbone right	1400kg	SS5561		
Wishbone left	1800kg	SS2245		1339460080
Wishbone right	1800kg	SS2246		1331641080
Ball joint	1400kg	SS2456		364032
Ball joint	1800kg	SS2457		364033
Mounting rear axle		SS4365		1311858080

CITROEN COMMERCIAL

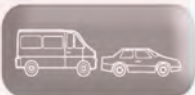

RELAY / JUMPER

06 -

STEERING



FRONT SUSPENSION



REAR SUSPENSION

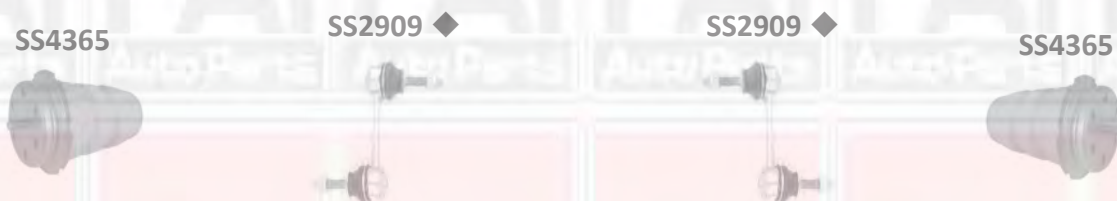

Description	Application Notes	Part No	Product Notes	OE Ref.No.
Tie rod end left		SS2753 ◆		381770
Tie rod end Right		SS2752 ◆		381769
Rack end		SS2798 ◆		
Wishbone left		SS2748 ◆		3520S0
Wishbone right		SS2749 ◆		3521P1
Wishbone left	2000kg	SS2750 ◆		3520S1
Wishbone right	2000kg	SS2751 ◆		3521P2
Ball joint		SS2747 ◆		364067
Front wishbone bush		SS2754 ◆		
Rear wishbone bush		SS2755 ◆		
Link rod front		SS2756 ◆		1357572080
Link rod rear		SS2909 ◆		5170F5
Mounting rear axle		SS4365		1311858080

